

User Manual

MX 1.2 + 1.3 Strada series

Release 1.04





INDEX

1 – MX Strada series in a few words	3
2 – What is in the kit?	5
3 – Powering	6
4 – What you can do via keyboard	7
4.1 – Set Date/Time	8
4.2 – Set backlight	8
4.3 – Set Video input	9
4.4 – Lap Time Setup (with GPS Module connected only)	10
4.5 – Counters management	10
4.6 – GPS & Tracks management	11
4.7 – System Information	12
5 – MX Strada series and the PC	13
5.1 – Connection to the PC	13
5.2 – Configuration of MX Strada series	13
5.2.1 – Channels configuration	14
5.2.2 – ECU Connection and configuration	18
5.2.3 – CAN2 Stream configuration	20
5.2.4 – CAN Expansions configuration	21
Setting LCU-One CAN	22
Setting Channel Expansion	23
Setting TC Hub.	24
Setting RIO_2a.	25
Setting Shift Lights Module.	27
Setting Steering Wheel 3 or GS Dash	28
5.2.5 – Math channels configuration	31
5.2.6 – Status variables configuration	32
5.2.7 – Parameters configuration	34
5.2.8 – Shift Lights and Alarms configuration	35
5.2.9 – Trigger commands configuration	40
5.2.10 – Icons manager configuration	43
5.2.11 – Display configuration	46
5.2.12 – SmartyCam stream setting	48
5.2.13 – CAN Output configuration (expert users only)	50
5.2.14 – Transmitting the configuration to MX Strada	52
5.3 – Managing a track on MX Strada with Race Studio 3	53
5.4 – ECU Driver builder	55
5.5 – The device window	57
5.5.1 – Live measures layer	58
5.5.2 – Online value forcing	58
5.5.3 – Setting reference Lap	60
5.5.4 – Setting Predictive Reference Lap	61
6 – On the track	63
7 – Data recall	64
8 – New firmware upgrade	65
9 – RPM	66
9.1 – RPM from ECU	66
9.2 – RPM via a 5-50V square wave or coil (150-400V)	66
10 – Connection with the expansions	68
10.1 – Rear cameras connection and management	68
11 – Technical specifications and drawings	71
11.1 – MX Strada series dimensions and pinout	72
11.2 – MX Strada harnesses	77
11.3 – MX Strada mirror cameras connections, dimensions, pinout and harnesses	84



1 – MX Strada series in a few words

What is MX Strada series?

MX Strada series is the new AiM dash that combines small dimensions, flexibility, usability and that may manage a wide range of channel inputs.

It features:

- ECU connection (CAN, RS232 and K-Line)
- 1 speed input
- 1 RPM input
- 8 analog/digital inputs
- 2 analog video camera inputs
- up to 8 configurable display pages
- a huge tracks database to automatically select the track you are racing on
- from 5 to 8 alarm LEDs
- 10 RGB LEDs that you may configure for clearly showing if you are improving or not.

What about ECU connection?

MX Strada series manages CAN, K-Line and RS232 ECU communication lines. Its huge database including more than 1500 ECU protocols is available.

Is MX Strada series an expandable device?

Yes. MX Strada series can be connected to various AiM expansions like GPS Module, Channel Expansion, TC Hub (necessary to connect thermocouple sensors) and LCU-One CAN to maximize your engine performances and to AiM SmartyCam to see your track performances on your PC with all the values you need in overlay.

Anything else?

You may connect up to two additional optional back cameras to the dedicated input in order to show a reverse mirror image directly on its display.



The table below shows the differences among the dashes.

FEATURE	MXG Strada	MXP Strada	MXS Strada	MXT Strada
Display	7" TFT	6" TFT	5" TFT	10" TFT
Resolution	800*480 pixels			1280*480 pixels
Contrast	1000:1	600:1		1.100:1
Brightness	700cd/m ² - 1,100 Lumen			800cd/m ²
Ambient Light Sensor	Yes			
Alarm Display Icons	Yes, freely configurable			
Alarm RGB LEDs	8 configurable	5 configurable	6 configurable	
Shift Lights	10 configurable RGB LEDs			
CAN Connection	2			
ECU Connection	CAN, RS232 or K-Line to 1.000 + industry leading ECUs			
External Modules	GPS Module, Channel Expansion, TC Hub (necessary to connect thermocouple sensors), Lambda Controller, SmartyCamHD			
Analog Inputs	8 fully configurable, max 500 Hz each			
Digital Inputs	1 speed input, coil RPM input			
Digital outputs	1 (1A each)			
Second CAN	Yes			
Body	Anodized Aluminium			
Pushbuttons	Metallic			
Connectors	2 AMP + 1Binder			
Dimensions	237*127.6*26 mm	189.6*106.4*24.9	169.4*97*23 mm	278*135*43.2 mm
Weight	950g	640g	480g	1.100 g
Power Consumption	400mA			450mA
Waterproof	IP65			

2 – What is in the kit?

MX Strada series kit includes:

- MX Strada series **standard version or with street icons** as shown here below
- USB cable
- 14 pins connector harness for ECU connection and power; it is available in **two versions**:
 - standard for ECUs communicating through CAN/RS232 protocol or
 - with the OBDII connector for ECUs communicating with CAN/RS232 and K-Line.



3 – Powering

The power is managed by two pins of the 14 pins connector:

- Pin 1: Power (9-15 Volts)
- Pin 2: Ground

They must be connected as shown in the following diagram.

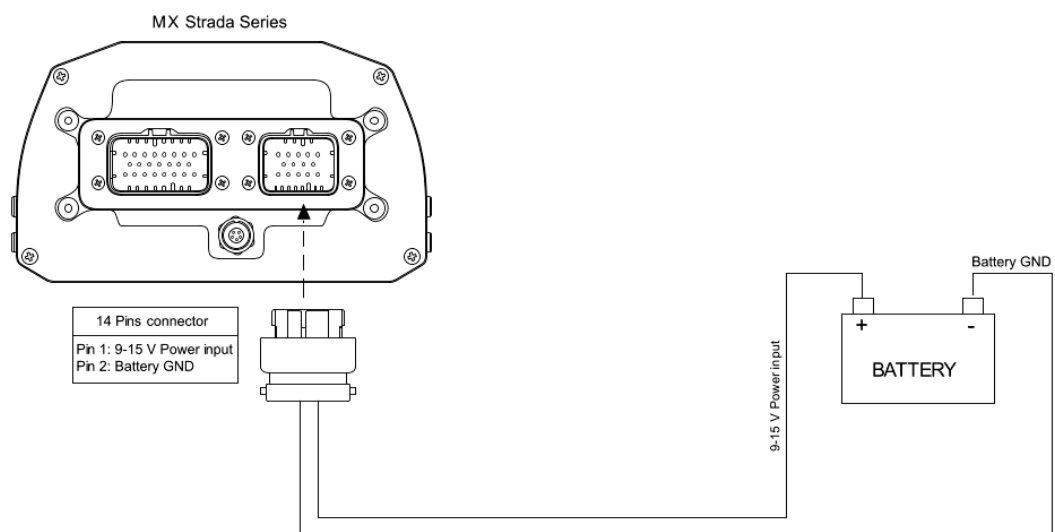

4 – What you can do via keyboard

MX Strada series needs to be configured via software but there are some functions you can manage via the device lateral buttons.

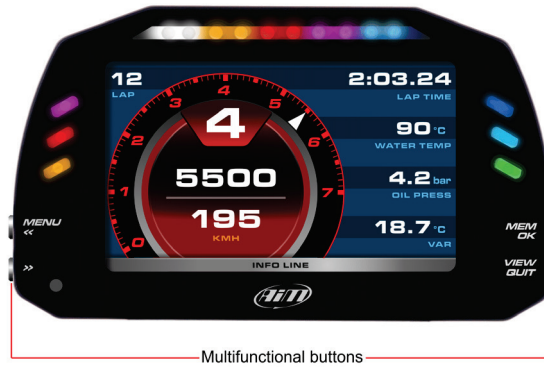

Press “Menu” button and this page appears.



The icons are to manage:



Date/Time



Backlight



Video in
(optional additional rear cameras)



Lap Time setup (with GPS Module connected only)

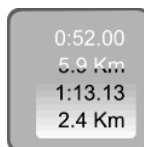

Counters



GPS and Tracks



System Info



4.1 – Set Date/Time

Here you can:

- set time and date format
- synchronize date and time with the data supplied by the connected GPS; in this case if a near track is available and set the system will set date and time of that track; if on the contrary there is no synchronization date and time need to be set manually

Bottom of the page current time and date are shown



4.2 – Set backlight

The brightness of the display and LEDs may be adjusted in two ways, depending on the light captured by a dedicated sensor integrated in the dash

- AUTOMATIC: in case ambient light is higher than a defined threshold, the brightness is reduced; you can set day and night brightness level as well as the brightness threshold value that switches from day to night mode (left image below)
- MANUAL: you may define the brightness of the display and LEDs choosing among some values: 20%, 40%, 60%, 80%, 100% (right image below)





4.3 – Set Video input

Video In page manages up to two additional optional back cameras (that cannot be logged).

They are to be connected to the Binder 712 female connector rear central of MX Strada Series, as shown in the pinout you find at the end of this user guide.

Features to set are:

- Input: Video 1 / Video 2
- Format: NTSC/PAL
- Brightness and Contrast from 10 to 100%

Use "CHANGE" button to set each feature and "NEXT" to scroll the features

Please refer to paragraph 10.1 ("Rear cameras connection and management") for further information.

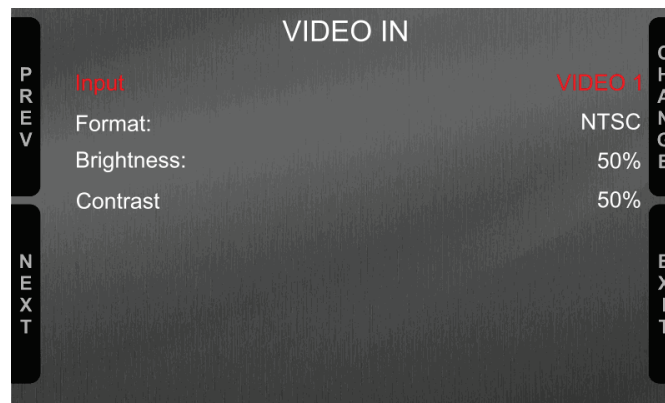



4.4 – Lap Time Setup (with GPS Module connected only)

Lap time setup allows the user to decide which lap time to use as reference for predictive lap time calculation. Available options are:

- Best Lap of test
- Best Lap of today
- Previous Lap
- User reference Lap (once you are on the track when the reference lap has been recorded MX Strada sets it). **Please note:** the user reference lap needs to be loaded on MX Strada using Race Studio 3 software as explained in paragraphs 5.5.3 and 5.5.4.

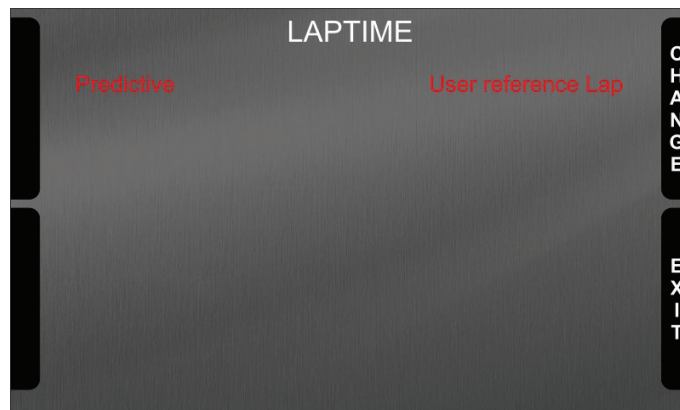

4.5 – Counters management

MX Strada series features 4 user odometers, labelled User 1 – User 4, plus a non-resettable System Odometer. All odometers are shown on the configuration software Race Studio 3 too (see chapter 5 – “MX Strada series and the PC”).

Each odometer can be activated/deactivated and/or reset. To manage an odometer select it and press “CHANGE”.

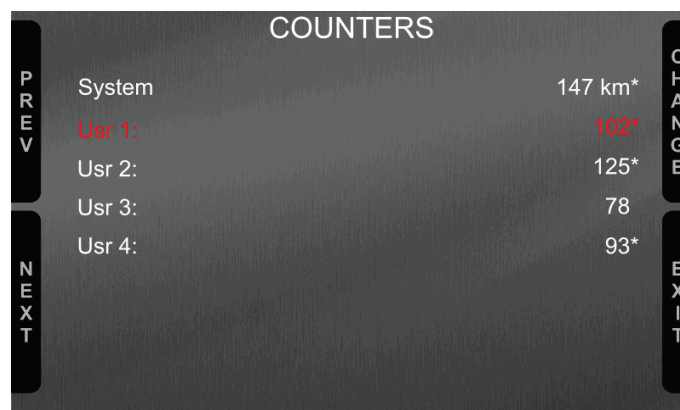



4.6 – GPS & Tracks management

MX Strada series can be used on track thanks to the optional AiM GPS09 Module. This is used for Lap time, Speed and Predictive lap time calculation

To calculate these data the system needs to know the start/finish line coordinates of the racetrack: MX Strada series comes with a long list of tracks, constantly updated by our technicians and loaded to your PC when you run Race Studio 3 software and a connection to the Internet is available. MX Strada series provides two track selection modes: automatic and manual.

Automatic:

MX Strada series automatically recognizes the track you are running on, loads the start/finish line and the possible splits coordinates and calculates lap and split times without optical/magnetic receiver. This is the best mode in most cases.

Manual:

Allows to manually select the track from the internal database.

This mode is to be preferred when multiple track configurations are available nearby. In this case MX Strada series would anyway recognize the track but would need at least one complete track lap.

You can scroll the list of available tracks choosing among these options:

- nearest: shows only tracks in a 10 km distance
- all: shows all tracks stored in the system in alphabetical order
- custom: shows only the tracks you have previously created

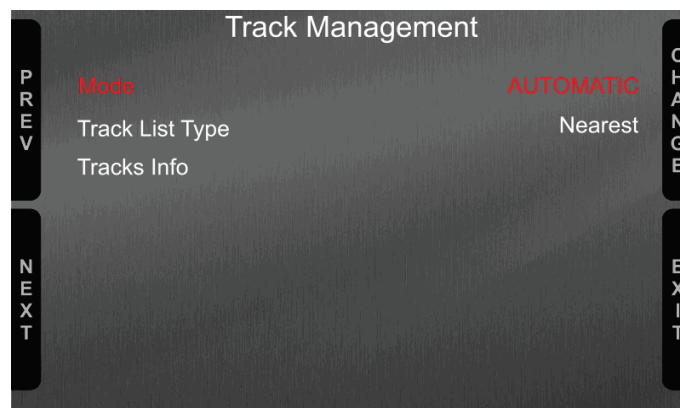

Scrolling up to “Tracks Info” you can see all tracks stored in MX Strada with their track map. Setting the track List Type on “Nearest” tracks will be listed by distance from your current position as shown here below.

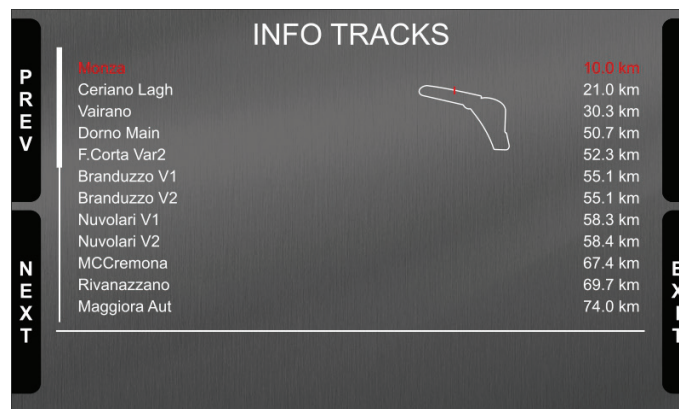



4.7 – System Information

This page shows serial number as well as firmware and booter version of MX Strada series dash. CAMBIARE IMMAGINE

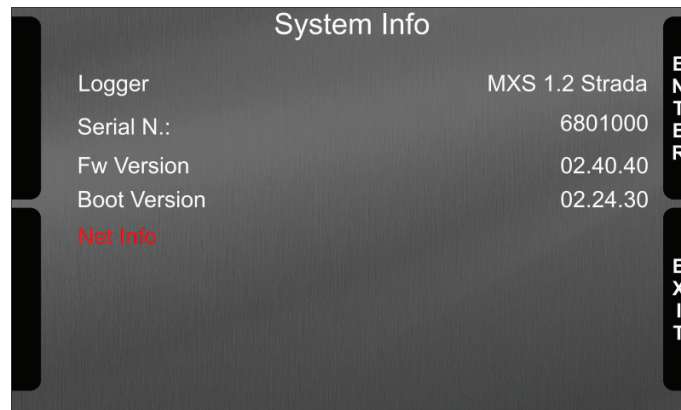

“Net info” option appears only if an expansion is connected to MX Strada, GPS included and pressing “ENTER” button the information of these expansion are shown as below.

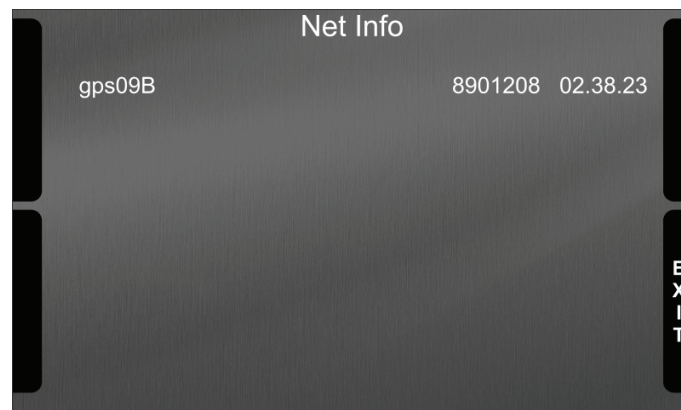

5 – MX Strada series and the PC

MX Strada series dash can be configured through AiM Race Studio 3 software; the software also manages its tracks database as well as checks other device functions through the device window.

5.1 – Connection to the PC

MX Strada series can be connected to the PC using the USB cable included in the kit: plug it in the cable labelled “USB” of MX Strada series 14 pins connector harness and in the PC USB port.

5.2 – Configuration of MX Strada series

Once MX Strada series connected to the PC

- click “Configurations” icon and configurations page appears
- click “New” and new configuration panel appears: select “MX Strada series” dash and press “OK”; when performing subsequent configurations “Select configuration” panel shows on top the last four devices you configured.

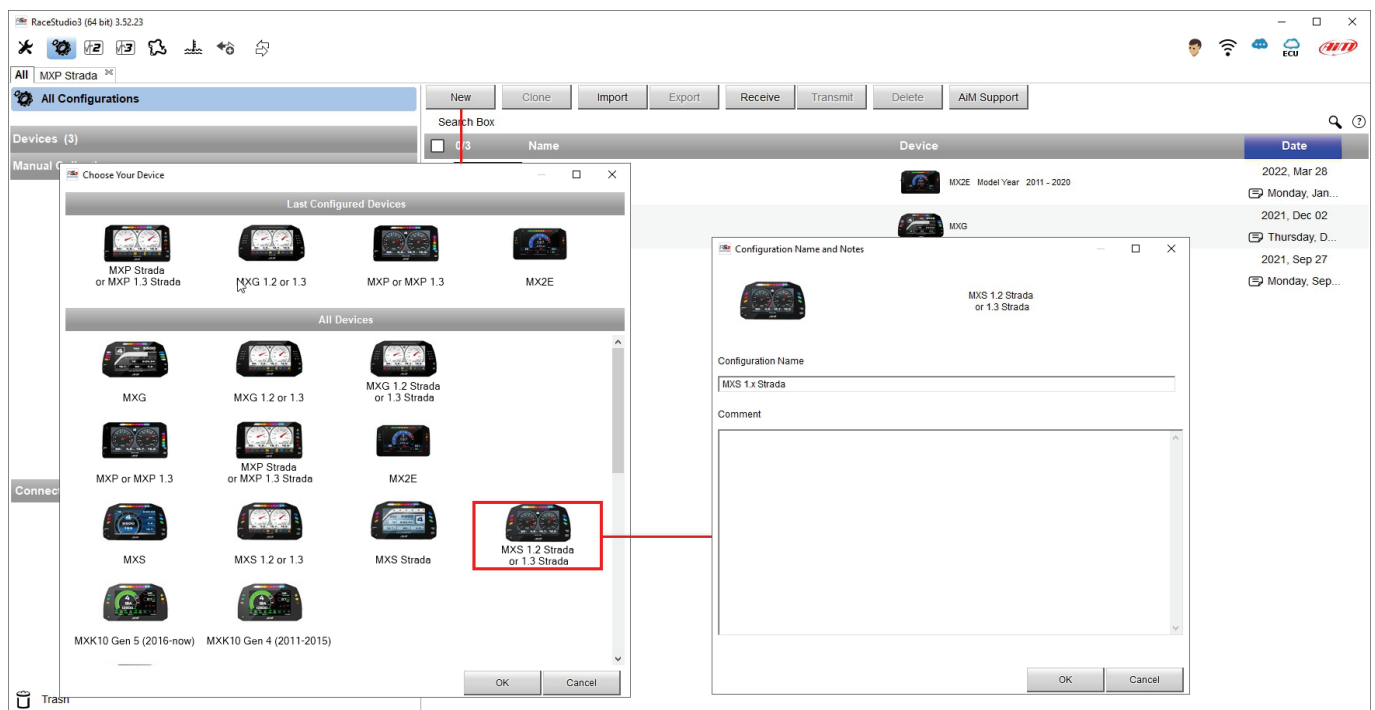

This is the list of the features you have to configure:

- Channels: analog and digital sensors directly connected to MX Strada series dash.
- ECU: the Engine Control Unit of the vehicle. MX Strada series dash manages CAN, RS232 and K-Line protocols
- CAN2: in case the system is connected to other CAN devices, beside the ECU, they have to be connected to CAN 2 port
- CAN expansions: other AiM CAN Devices, like, for example, Lambda controller, GPS Module, Channel expansions, TC Hub necessary to connect thermocouples to MX 1.3 Strada, etc.
- Math channels: some calculated channels that may be helpful in some situations
- Some other calculated variables, useful for managing alarms, icons, LEDs.

5.2.1 – Channels configuration

To set all the channels.

RPM channel is by default enabled: since the direct RPM connection is used when the vehicle does not have an ECU. The software automatically disables it when an ECU protocol is selected. See chapter 9 for further information about the hardware RPM signal connection.

The screenshot shows the RaceStudio3 interface with the 'Channels' tab selected. A table lists various channels with their configurations. The 'RPM' channel is highlighted with a red circle.

ID	<input checked="" type="checkbox"/>	Name	Function	Sensor	Unit	Freq	Parameters
RPM	<input checked="" type="checkbox"/>	RPM	Engine RPM	RPM Sensor	rpm	20 Hz	max: 16000 ; factor: /1 ;
Spd	<input type="checkbox"/>	Speed	Vehicle Spd	Speed Sensor	km/h 0.1	20 Hz	wheel: 1600 ; pulses: 1 ;
Ch01	<input checked="" type="checkbox"/>	Channel01	Voltage	Generic 0-5 V	mV	20 Hz	
Ch02	<input checked="" type="checkbox"/>	Channel02	Voltage	Generic 0-5 V	mV	20 Hz	
Ch03	<input checked="" type="checkbox"/>	Channel03	Voltage	Generic 0-5 V	mV	20 Hz	
Ch04	<input checked="" type="checkbox"/>	Channel04	Voltage	Generic 0-5 V	mV	20 Hz	
Ch05	<input checked="" type="checkbox"/>	Channel05	Voltage	Generic 0-5 V	mV	20 Hz	
Ch06	<input checked="" type="checkbox"/>	Channel06	Voltage	Generic 0-5 V	mV	20 Hz	
Ch07	<input checked="" type="checkbox"/>	Channel07	Voltage	Generic 0-5 V	mV	20 Hz	
Ch08	<input checked="" type="checkbox"/>	Channel08	Voltage	Generic 0-5 V	mV	20 Hz	
PAccu	<input checked="" type="checkbox"/>	GPS PosAccuracy	GPS Accuracy	GPS	m 0.01	10 Hz	
Spd	<input checked="" type="checkbox"/>	GPS Speed	Vehicle Spd	GPS	km/h 0.1	10 Hz	
Alt	<input checked="" type="checkbox"/>	Altitude	Altitude	GPS	m	10 Hz	
OdD	<input checked="" type="checkbox"/>	Odometer	Odometer Total	Odometer	km 0.1	1 Hz	
Luma	<input checked="" type="checkbox"/>	Luminosity	Brightness	Luminosity	%	1 Hz	
Fuel	<input type="checkbox"/>	FuelUsed	Fuel Level	Fuel Used	l 0.1	10 Hz	
Tlog	<input checked="" type="checkbox"/>	LoggerTemp	Temperature	Logger Temperature	C	1 Hz	

To set a channel just click on its line and the related panel shows up.

The first two channels in the list are RPM and speed, follows the configurable channels that can be managed as analog or as digital according to what they are connected to.

Typically analog sensors are pressure sensors, thermocouples (TC Hub needed to connect them MX1.3 Strada devices), potentiometers, etc... while digital inputs are used for managing pushbuttons, that may be used for activating the digital outputs

Selecting “**Analog**” options to be set are:

- Channel name
- Function: this parameter is useful in the data analysis process
- Sensor type
- Sampling frequency
- Unit of Measure

Additional parameters to be set according to the sensor type set can be:

- Display precision: it configures how many decimal digits will be shown on the display
- Specific parameters

In the following image you see two different channels configuration windows.

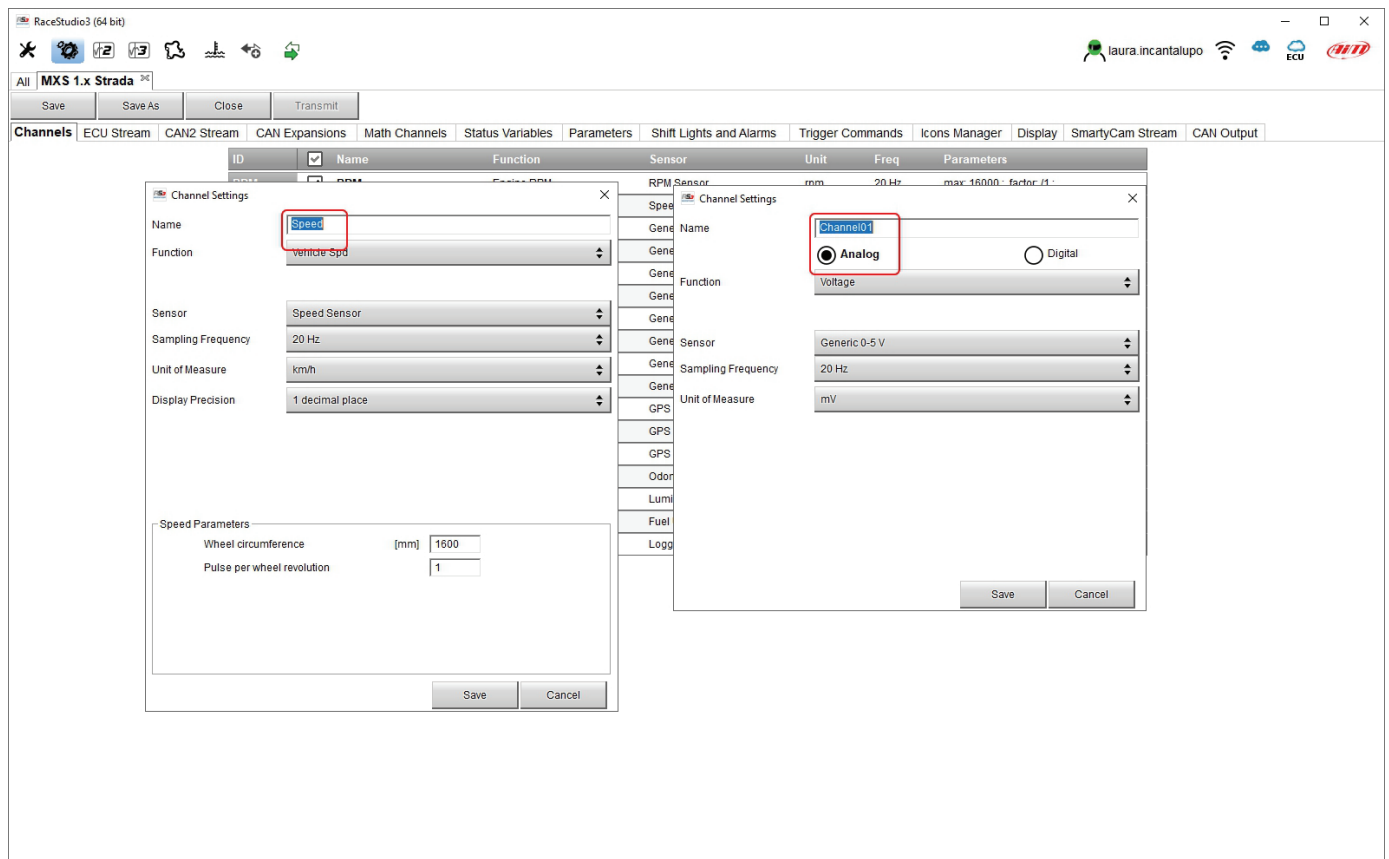

If you need to use an input as **“Digital Input”** you have to configure its parameters as explained in the following pages.

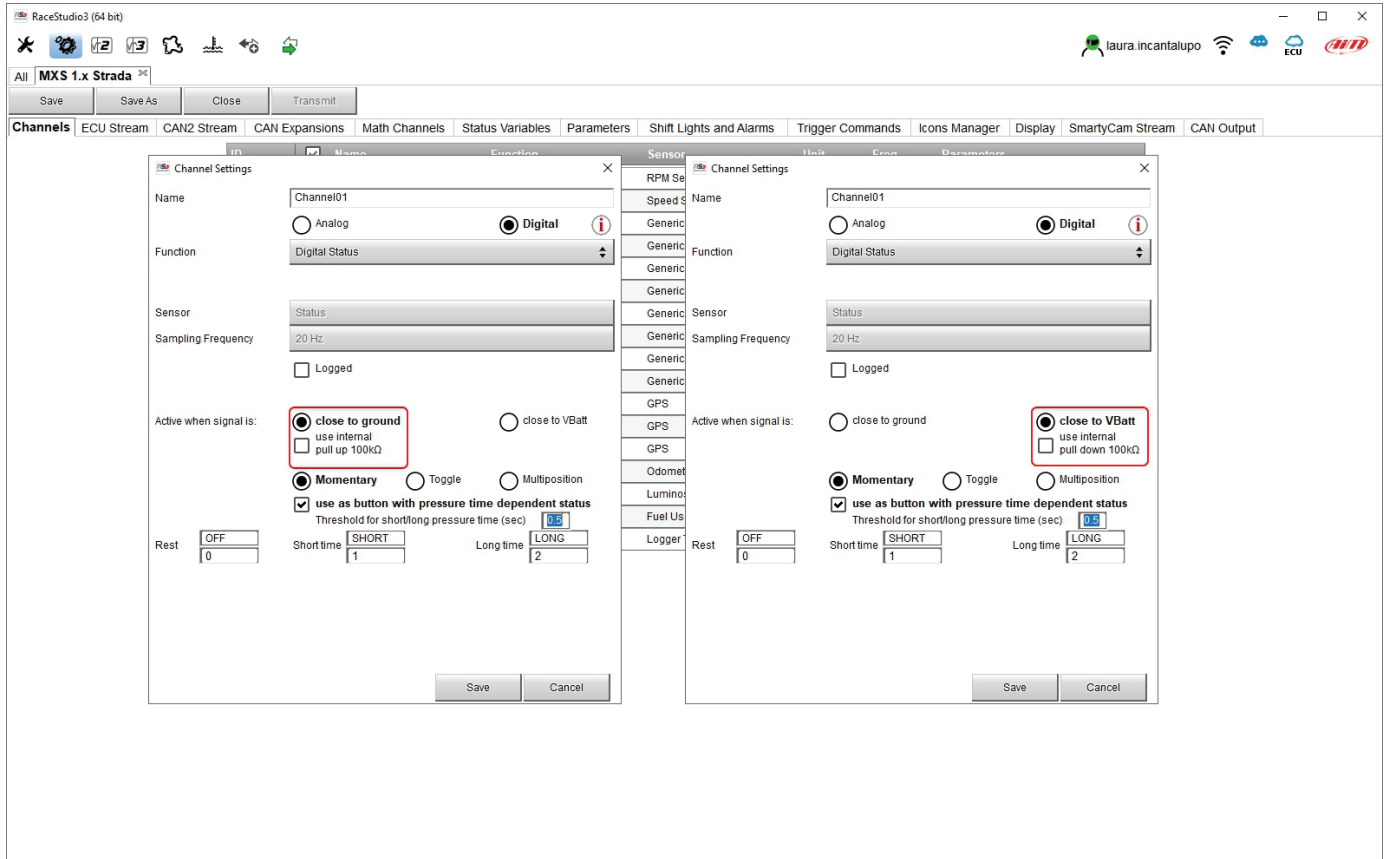

- **Working mode:** a digital input can work in two different ways:
 - The pushbutton closes to ground (with or without pull up resistor – left image below)
 - The pushbutton closes to VBattery (with or without pull down resistor – right image below)

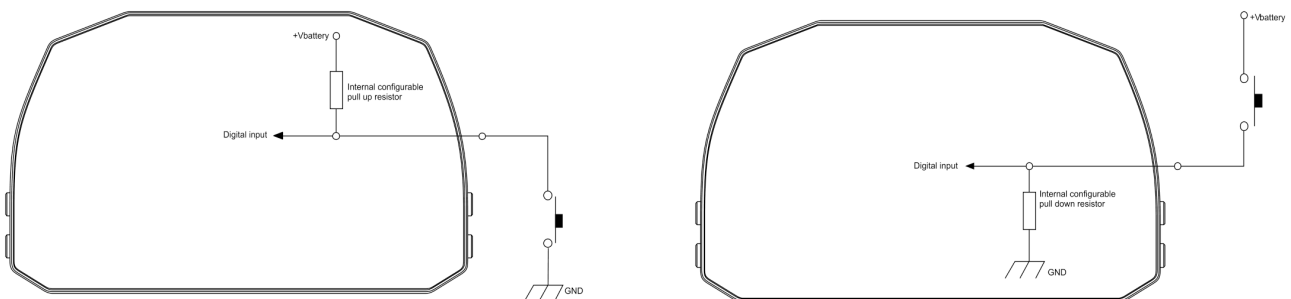

- **Active/Not Active** labels: according to the status a Digital channel may assume the values 0/1, High/Low, ON/OFF, Closed/Open, True/False etc...max number of characters for the label is 5
The two different labels can be defined and eventually shown on the display, used by Math channels, Icons Management, alarm managements and in general, any time a digital channel is required; the labels appears in Device page too.
- **Signal Type:** can be momentary, toggle or multiposition, to say:
 - **Momentary:** the channel is active when the pushbutton is pressed
 - **Toggle:** the channel is activated the first time the button is presser and deactivated the second time the button is pressed
 - **Multiposition:** the channel can take different status according to the number of pressure and it is possible to add status using the "+" button that appears right of the panel once "Multiposition" option is selected.
 - **Use as button with pressure dependent status:** it is possible to configure pressure time so that once the threshold value is reached the pressure time switches from short to long and the channel from one status to the other. The image here below shoes its working mode.

MOMENTARY

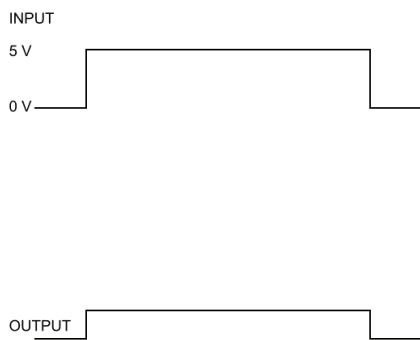

MOMENTARY WITH TIME THRESHOLD

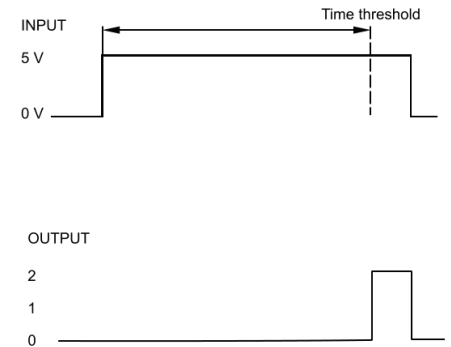
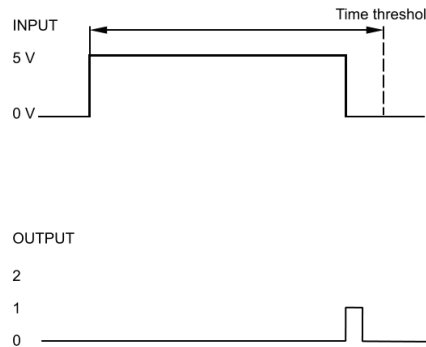

TOGGLE

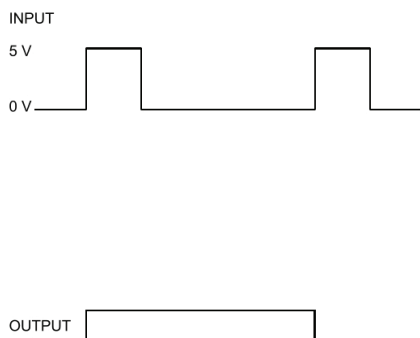

TOGGLE WITH TIME THRESHOLD

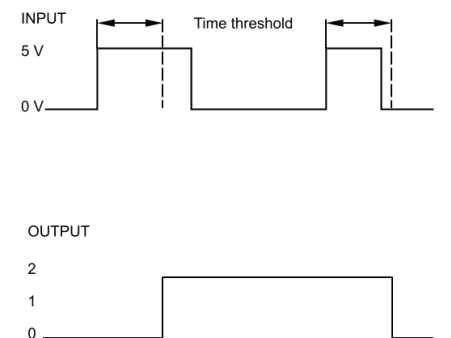
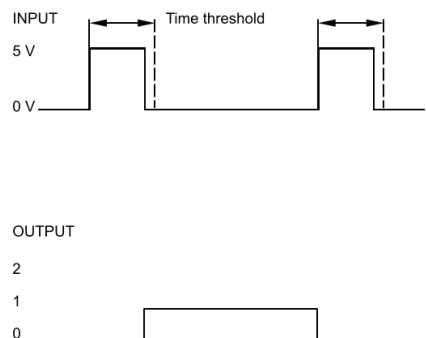

5.2.2 – ECU Connection and configuration

MX Strada series can be connected to the vehicle ECU. Documents explaining how to connect MX Strada series to the ECU are published on our website www.aim-sportline.com and a PDF file with protocols updates history can be downloaded clicking the ECU icon you find on the top right keyboard of the software view as shown here below. MX Strada series can communicate through CAN, RS232 and K-Line communication lines.

The ECU protocol database includes more than 1500 different protocols and is constantly updated by our technicians. In case of a CAN based ECU whose protocol is not in the database, the ECU Driver Builder function (paragraph 5.4) allows to develop it.

To load the ECU protocol in MX Strada series configuration:

- enter “ECU Stream” tab
- press “Change ECU” button
- select “ECU Manufacturer” and “ECU Model” (in the example FORD/ MUSTANG 2010)
- press OK

The screenshot shows the RaceStudio3 software interface. The 'ECU Stream' tab is selected in the top menu. A 'Change ECU' button is highlighted with a red box. A dialog box titled 'Choose ECU Protocol' is open, displaying a list of manufacturers and models. The 'FORD' manufacturer and 'MUSTANG 2010' model are selected. A red line connects the 'Change ECU' button to the 'Show ECU Protocols Updates History' button in the top right corner.

Manufacturer	Model	Version	Protocol
ELECTROMOTIVE	BOSS 302R X05 OF	(v. 02.00.00)	(CAN)
EM	FIESTA	(v. 02.00.00)	(CAN)
EMERALD	FIESTA ST150	(v. 02.00.01)	(CAN)
EMOTICOM	FOCUS 2005 07	(v. 02.00.00)	(CAN)
EMS	FOCUS 2008	(v. 02.00.00)	(CAN)
EMTRON	FOCUS PZEV0304	(v. 02.00.00)	(CAN)
FARTSTRUP	FOCUS_2013	(v. 02.00.02)	(CAN)
FAST	FR500C_MS	(v. 02.00.01)	(CAN)
FERRARI	FiestaCup 2019	(v. 2.00.04)	(CAN)
FIAT ABARTH	MUSTANG 2005-9	(v. 02.00.00)	(CAN)
FORD	MUSTANG 2010	(v. 02.00.00)	(CAN)
FPT	MUSTANG 2011	(v. 02.00.05)	(CAN)
FUEL_TECH	MUSTANG 2015	(v. 02.00.00)	(CAN)
GEMS			
GET			
GINETTA			
GM			
HALTECH			
HOLLEY			



After setting the protocol the system comes back to “ECU Stream” page and two checkbox appears:

- “Enable the CAN Bus 120 Ohm Resistor” (enabled by default; to be disabled in case MX Strada series dash is additional to the vehicle one): the CAN bus needs two 120 Ohm resistors at its two extremes. In case MX Strada series dash is the only device connected to the ECU the 120 Ohm resistor should be enabled, else, very easily, it is already present in the existing network and should be disabled;
- “silent on CAN Bus” (disabled by default): usually the ECU expects an acknowledge signal when transmits a message and, as default, the MX Strada series transmits this signal. Sometimes, particularly when there are other devices in the network, MX Strada series should not transmit it; in this case, enabling this flag, MX Strada series dash remains completely silent.

ECU: FORD - MUSTANG 2010 (ver. 02.00.00) 500 Kbit/sec

Enable the CAN Bus 120 Ohm Resistor

Silent on CAN Bus

Enabled Channels (Max. 120) 35 / 35

ID	✓	Name	Function	Unit	Freq
CC08	✓	RPM	Engine RPM	rpm	10 Hz
CC09	✓	SpeedVeh	Vehicle Spd	km/h 0.1	10 Hz
CC13	✓	SpeedFL	Wheel Spd	km/h 0.1	10 Hz
CC14	✓	SpeedFR	Wheel Spd	km/h 0.1	10 Hz
CC15	✓	SpeedRL	Wheel Spd	km/h 0.1	10 Hz
CC16	✓	SpeedRR	Wheel Spd	km/h 0.1	10 Hz
CC17	✓	Gear	Gear	gear	10 Hz
CC25	✓	WaterTemp	Water Temp	C 0.1	10 Hz
CC04	✓	TurboBoost	Number	#	10 Hz
CC21	✓	TCSBrakeEvent	Number	#	10 Hz
CC22	✓	TCSEngEvent	Number	#	10 Hz
CC23	✓	StabCtrlTetaI	Number	#	10 Hz
CC24	✓	StabCtrlMTXT	Number	#	10 Hz
CC34	✓	TyreRvMile	Number	#	10 Hz
CC31	✓	FuellLevelMean	Percent	% 0.01	10 Hz
CC32	✓	FuellInst1	Percent	% 0.01	10 Hz
CC33	✓	FuellInst2	Percent	% 0.01	10 Hz
CC35	✓	AxleRatio	Number	#	10 Hz
CC10	✓	PedalPosition	Percent	% 0.01	10 Hz
CC01	✓	YawRate	Yaw Rate	deg/s 0.1	10 Hz
CC02	✓	LateralAcc	Lateral Accel	g 0.01	10 Hz
CC03	✓	SWAngle	Steering Pos	deg 0.1	10 Hz
CC05	✓	TrqAct	Torque	Nm 0.1	10 Hz
CC06	✓	TrqSource	Number	#	10 Hz
CC07	✓	BrakeLampSw	Number	#	10 Hz
CC11	✓	ABSEvent	Number	#	10 Hz

5.2.3 – CAN2 Stream configuration

This page works exactly like ECU Stream one. Here are additional CAN modules. To load one:

- enter “CAN2 Stream” tab
- press “Change protocol” button
- select “Manufacturer” and “Model” (in the example MEGALINE/PADDLESHIFT)
- press OK

As for ECU Stream a PDF file with protocols updates history can be downloaded clicking the ECU icon you find on the top right keyboard of the software view.

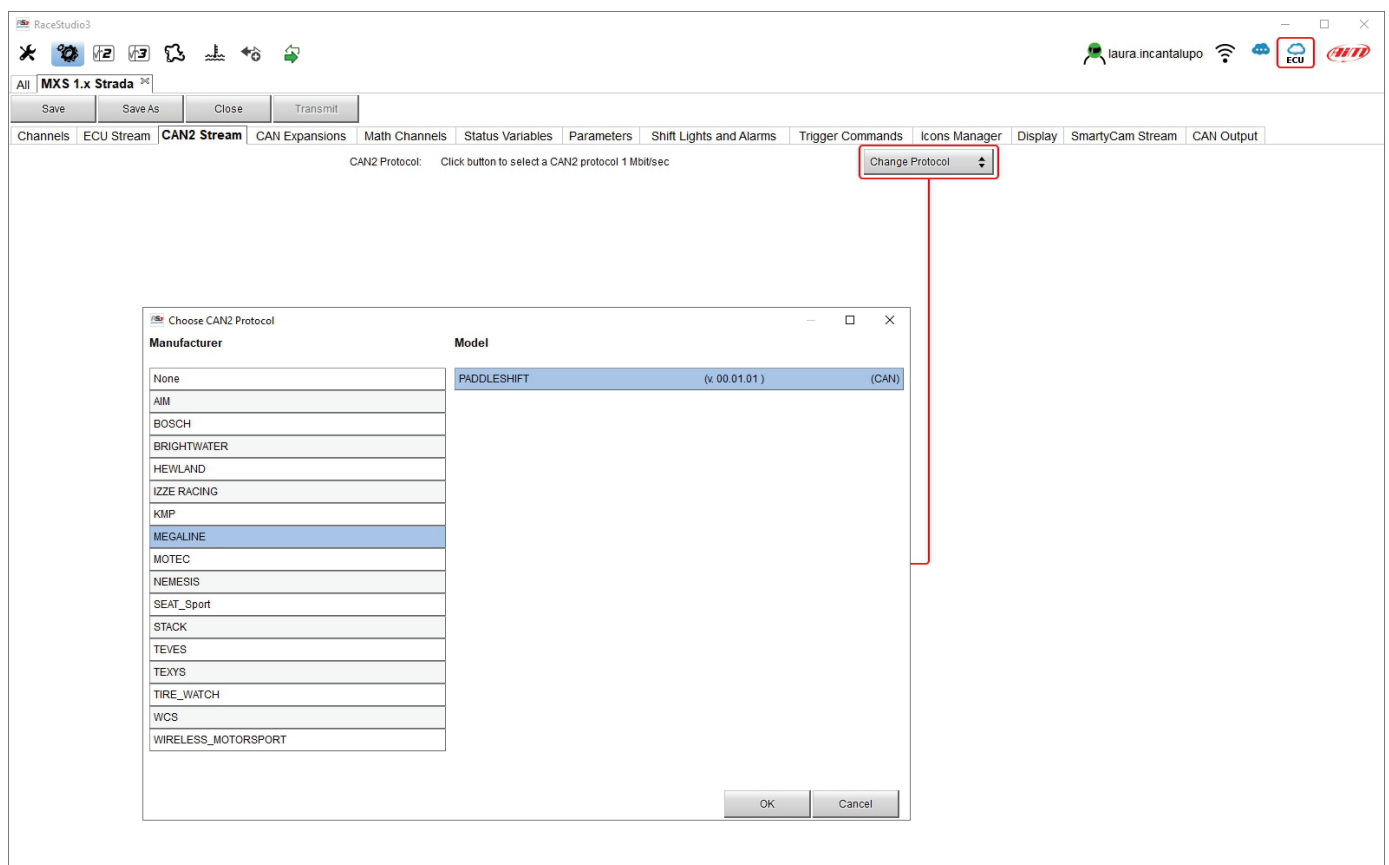

5.2.4 – CAN Expansions configuration

MX Strada series can be connected to various AiM CAN expansions:

- LCU-One CAN
- Channel Expansions
- TC Hub (necessary to connect thermocouple sensors to MX 1.3 Strada)
- RIO_02a or RIO 02b
- Shift Light Module
- Steering wheel 3
- GS Dash

At the very first MX Strada series connection this page shows up:

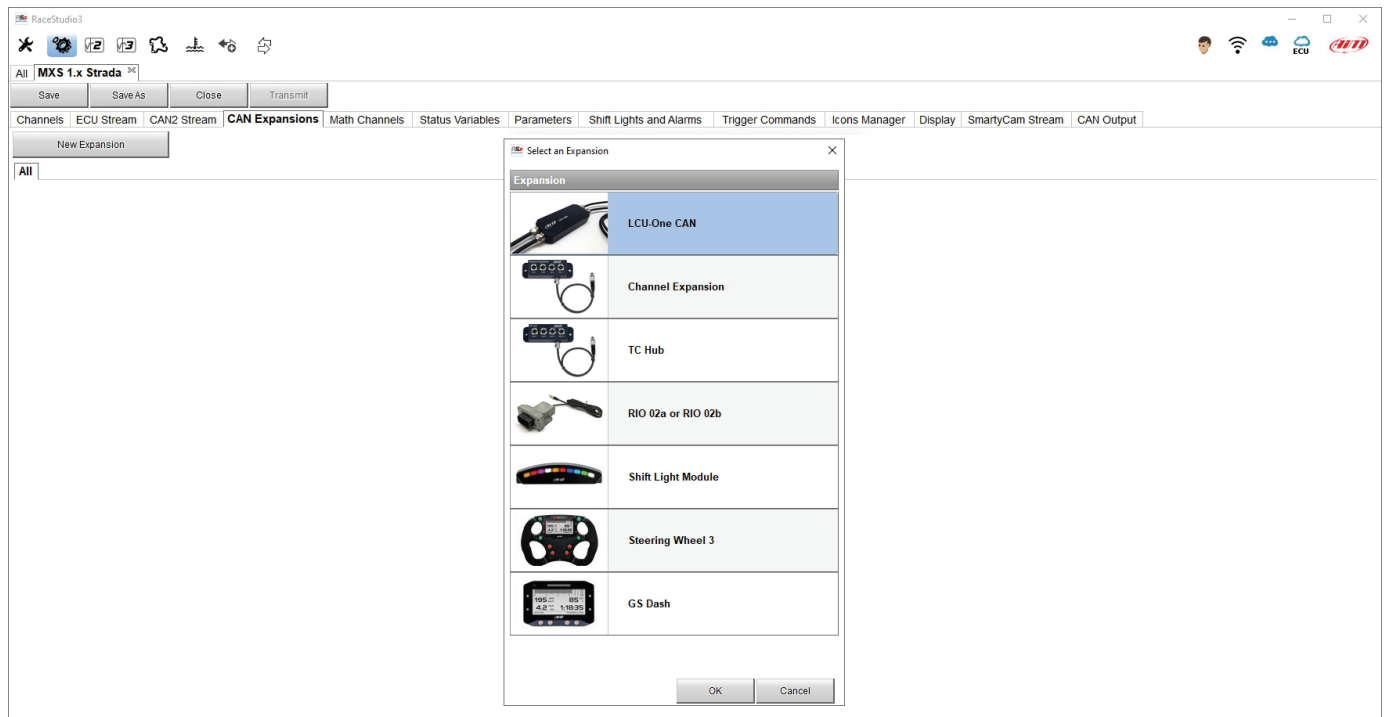

Select the CAN expansion to set and press "OK". Each expansion needs to be set filling in the related panel.

Setting LCU-One CAN

To set an LCU-One CAN:

- press "New Expansion" button;
- select "LCU-One CAN" and press OK
- name the LCU One and fill in its serial number or press "Get SN from a connected expansion" to receive the serial number from the connected LCU-One
- select the multiplier to calculate AFR from lambda (in the example "14.57 Gasoline") or add a custom value pressing "Add Custom Value" (the related panel shows up: fill it in)
- set the LCU One channels double clicking on each channel and setting the panel that shows up
- press "Close" to save and exit

Expansion Name (6 Characters Max.)

Expansion Serial Number (S.N.)

Multiplier to calculate AFR (AFR) from lambda (AFR = Air Fuel Ratio = pounds of air / pound of fuel)

14.57 - Gasoline

ID	Name	Function	Sensor	Unit	Freq
Lmd	<input checked="" type="checkbox"/> 0Lambda	Lambda	LCU-One Lambda	lambda 0.01	10 Hz
AFR	<input checked="" type="checkbox"/> 0AFR	AFR	LCU-One AFR	AF 0.01	10 Hz
LTrm	<input checked="" type="checkbox"/> 0LmdTmp	Lambda Temp	LCU-One Temp	C 0.1	10 Hz
LDg	<input checked="" type="checkbox"/> 0Diagn	Lambda Diagn	LCU-One Diagn	#	1 Hz

Close

Lambda Multiplier Manager

Multiplier Lambda Values	New Value	Label for New Value
6.40 - Methanol	14.57	Gasoline
9.00 - Ethanol		
14.57 - Gasoline		
14.60 - Diesel		
15.50 - LPG (Propane)		
17.20 - CNG		

Please note: for any further information about AiM LCU-One CAN refer to the related user manual you can download from AiM website www.aim-sportline.com documentation area, products section.

Setting Channel Expansion

To set a Channel Expansion:

- press “New Expansion” button;
- select “Channel Expansion” and press OK
- name the Channel expansion and fill in its serial number or press “Get SN from a connected expansion” to receive the serial number from the connected Channel Expansion
- set each channel double clicking on each channel and setting the panel that shows up (it works exactly like channels configuration – see the related paragraph)
- press “Close” to save and exit

The screenshot shows the RaceStudio3 interface. The 'CAN Expansions' tab is active, displaying a table of channels. A red box highlights the table, and a red line connects it to the 'Channel Settings' dialog box.

ID	Name	Function	Sensor	Unit	Freq
C01	0CHX 0Channel01	Voltage	Generic 0-5 V	mV	20 Hz
C02	0CHX 0Channel02	Voltage	Generic 0-5 V	mV	20 Hz
C03	0CHX 0Channel03	Voltage	Generic 0-5 V	mV	20 Hz
C04	0CHX 0Channel04	Voltage	Generic 0-5 V	mV	20 Hz

The 'Channel Settings' dialog box shows the following configuration for '0CHX 0Channel01':

- Name: 0CHX 0Channel01
- Function: Analog (selected), Digital
- Sensor: Generic 0-5 V
- Sampling Frequency: 20 Hz
- Unit of Measure: mV

Please note: for any further information about AiM Channel expansion refer to the related user manual you can download from AiM website www.aim-sportline.com documentation area, products section.

Setting TC Hub.

This CAN expansion only supports K type thermo-couples and is necessary to connect MX 1.3 Strada devices to thermocouple sensors.

To set a TC Hub:

- press “New Expansion” button;
- select “TC Hub” and press OK
- name the TC Hub and fill in its serial number or press “Get SN from a connected expansion” to receive the serial number from the connected TC Hub
- for each channel set sampling frequency, measure unit and display precision
- press “Close” to save and exit

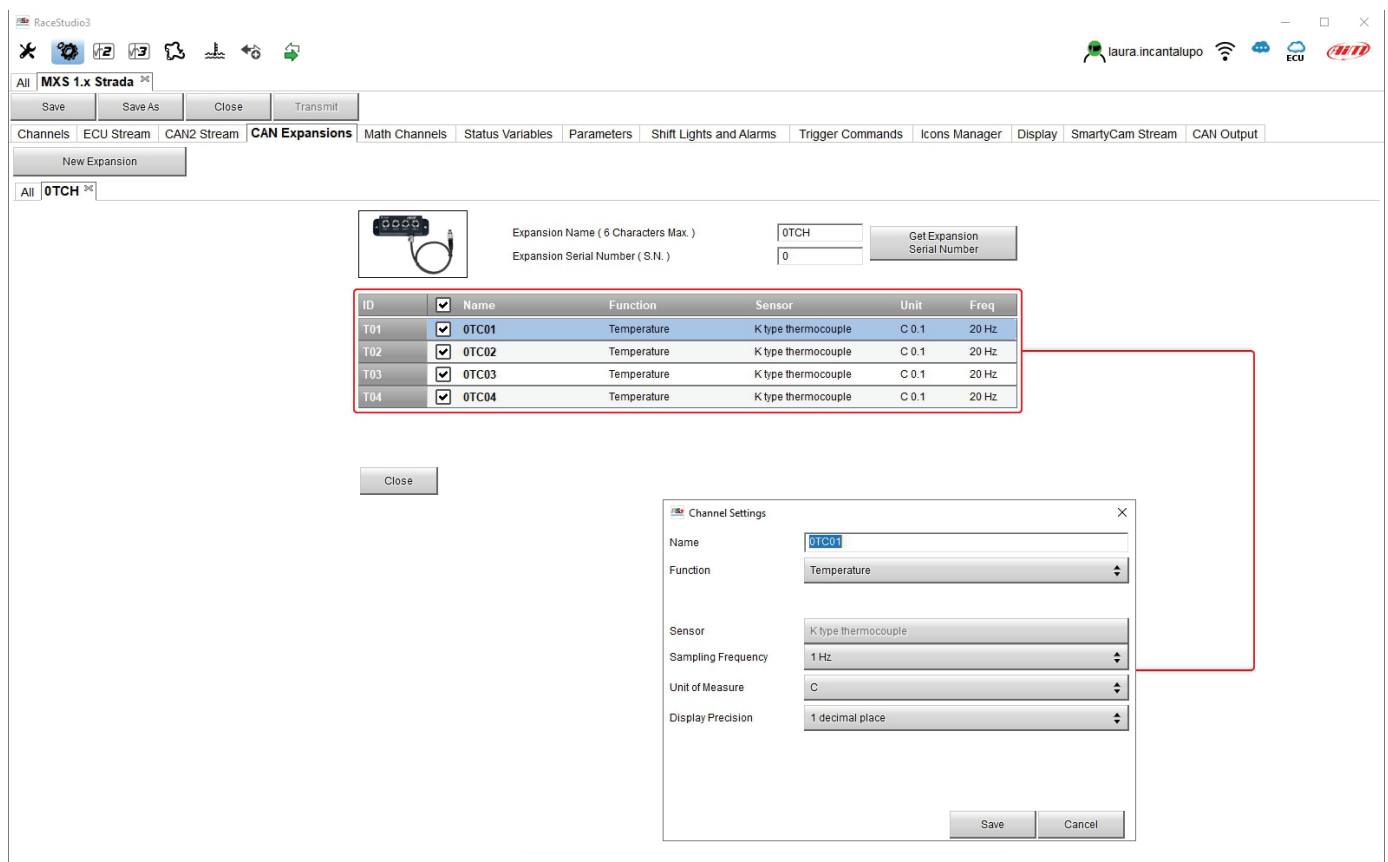

Please note: for any further information about TC Hub refer to the related user manual you can download from AiM website www.aim-sportline.com documentation area, products section.

Setting RIO_2a.

This CAN expansion allows to manage external switches.

To set a RIO_2a:

- press “New Expansion” button;
- select “RIO_02a” and press OK
- name the RIO_02a and fill in its serial number or press “Get SN from a connected expansion” to receive the serial number from the connected RIO_02
- RIO_02a channels work exactly as all MX series channels; please refer to paragraph 6.2.1 to set the channels
- press “Close” to save and exit

The screenshot shows the RaceStudio3 interface. At the top, there's a menu bar with options like 'Save', 'Save As', 'Close', and 'Transmit'. Below that, a toolbar contains various icons. The main window displays 'All MXS 1.x Strada' and a 'New Expansion' button. A sub-window shows 'All R2' with an image of the expansion module. Fields for 'Expansion Name (6 characters max.)' (R2a) and 'Expansion Serial Number (S.N.)' (0) are visible, along with a 'Get Expansion Serial Number' button.

The 'RIO 02a Channels' section contains a table with 19 channels, each with a checked checkbox, name, function, sensor, unit, and frequency.

ID	Name	Function	Sensor	Unit	Freq
Ch01	R2a Channel01	Digital Status	Status		20 Hz
Ch02	R2a Channel02	Digital Status	Status		20 Hz
Ch03	R2a Channel03	Digital Status	Status		20 Hz
Ch04	R2a Channel04	Digital Status	Status		20 Hz
Ch05	R2a Channel05	Digital Status	Status		20 Hz
Ch06	R2a Channel06	Digital Status	Status		20 Hz
Ch07	R2a Channel07	Digital Status	Status		20 Hz
Ch08	R2a Channel08	Digital Status	Status		20 Hz
Ch09	R2a Channel09	Digital Status	Status		20 Hz
Ch10	R2a Channel10	Digital Status	Status		20 Hz
Ch11	R2a Channel11	Digital Status	Status		20 Hz
Ch12	R2a Channel12	Digital Status	Status		20 Hz
Ch13	R2a Channel13	Digital Status	Status		20 Hz
Ch14	R2a Channel14	Digital Status	Status		20 Hz
Ch15	R2a Channel15	Digital Status	Status		20 Hz
Ch16	R2a Channel16	Digital Status	Status		20 Hz
Ch17	R2a Channel17	Digital Status	Status		20 Hz
Ch18	R2a Channel18	Digital Status	Status		20 Hz
Ch19	R2a Channel19	Digital Status	Status		20 Hz

The 'Channel Settings' dialog box for 'R2a Channel06' is open, showing the following configuration:

- Name: R2a Channel06
- Function: Digital Status
- Sensor: Status
- Sampling Frequency: 20 Hz
- Logged:
- Active when signal is: close to ground, close to VBatt
- Momentary: Toggle: Multiposition:
- use as button with pressure time dependent status:
 - Threshold for short/long pressure time (sec): 0.5
- Rest label: OFF [0]
- Short time label: SHORT [1]
- Long time label: LONG [2]

To set a new output:

- fill in output name (1)
- choose channel, working mode and specify if all condition are to be satisfied or only one of them (2-4)
- decide if the circuit is to be open or closed (5)
- decide ending condition ("Untill" – 6) among "condition no longer met", "the device is turned off", "a button is pushed" "data are downloaded"
- "+" buttons right of the panel are to add a new condition (top one) or a new output (bottom one)
- once all operations performed press "Save" in "Create New Alarm" panel.

The screenshot shows the 'Create New Output' dialog box in RaceStudio3. The dialog is titled 'Create New Output' and has a 'Description' field (1) and an 'Import/Export' section. Below this is a 'Conditions' section (2-4) where a condition is set to 'RPM' (2) and 'greater than' (3) with a value of '0'. The 'Alarm actions in RIO_02a' section (5) shows 'Output 1' set to 'Open Circuit'. The 'Until' section (6) shows the condition 'condition no longer met'. A 'Select Channel' dialog is also open, showing a list of channels with 'Channel01' selected under the 'RPM' source. Red boxes and numbers 1-6 highlight the key steps in the configuration process.

Setting Shift Lights Module.

This CAN expansion works exactly as MX Strada Shift Lights and can be placed in a position more comfortable than the shift lights for the racer.

To set Shift Light Module:

- press "New Expansion"
- select "Shift Light Module" and press OK
- the module works exactly like MX Strada series shift lights so available options are:
 - use for predictive time
 - use as gear shift lights
- set it as explained in paragraph 5.2.8 and press "SAVE" CAMBIARE IMMAGINE

Use for predictive time Use as gear shift lights

Gear	Shift Light 1	2	3	4	5	6	7	8	9	10	
All	8200	8400	8600	8800	9000	9200	9400	9600	9800	10000	⚙️

Activate Simulation

Setting Steering Wheel 3 or GS Dash

Steering Wheel and GS Dash are configured in the same way but you can install only one of them

- press "New Expansion";
- select "Formula Steering Wheel 3" and press OK
- the panel here below shows up: select the preferred page layout and press "OK" or double click on the desired layout.

The screenshot shows the RaceStudio3 interface with a 'Select a page to add' dialog box open. The dialog displays several dashboard page layouts (P1 through P16) with various data elements like speed, RPM, oil pressure, battery voltage, and gear. The P4 layout is highlighted with a red border. The background interface shows the 'CAN Expansions' menu and a 'Display' button.

Page ID	Layout Description
P1	Speed (195 km/h)
P2	Speed (195 km/h) and RPM (5500)
P3	LAM (0.9), OILP (4.2 bar), WT (85 C)
P4	WT (85 C), OILP (4.2 bar), Batt (12.5 V), LAM (0.9 A/F)
Bargraph	Speed (195 km/h) and RPM (85) bargraph
4-gear	WT (85 C), Batt (12.5 V), OILP (4.2 bar), LAM (0.9 A/F)
P8	OILP (4.2 bar), WT (85 C), Batt (12.5 V), LAM (0.9 A/F), TP (0.7 bar)
P16	Complex layout with multiple data points: OILP (4.2), WT (85), Batt (12.5), LAM (0.9), TP (0.7), and various other sensors.



The module allows to configure both display page and shift lights and alarms and works exactly like them (paragraph 5.2.8) and is to be configured in the same way.

To configure the **display**

- select the display area where to place the desired channel or the not set row
- choose the group of channels and then the channel to show and double click on it to place it in the desired area
- the row becomes configured
- repeat the operation for all the display areas and press "SAVE"

The screenshot shows the RaceStudio3 interface. The main display area is titled 'Page 1' and contains four data points: 'N Gear', '1:18:35 LapT', '1:18:35 PreT', and '0.1 Spd km/h'. Below the display is an 'INFO LINE' and a configuration table. The table has columns for 'Gear', 'Lap Time', 'Predictive Time', and 'SpeedVeh'. The 'Gear' column has a '1' in a circle, and the 'Lap Time' column has a '5' in a circle. The 'SpeedVeh' column has a 'km/h' unit. The 'Channels' list on the right shows 'Gear' selected under the 'Channel Groups'.

Channel	Value
Gear	N
Lap Time	1:18:35
Predictive Time	1:18:35
SpeedVeh	0.1 km/h

Channel	Value
Gear	N
Lap Time	1:18:35
Predictive Time	1:18:35
SpeedVeh	0.1 km/h

Shift lights can be set as gear shift lights or for predictive time and it is possible to add new alarms. Please refer to paragraph 5.2.8 to know how to configure shift lights and alarms.

The screenshot shows the RaceStudio3 software interface. The main window is titled "MXS 1.x Strada" and has a menu bar with options: Channels, ECU Stream, CAN2 Stream, CAN Expansions, Math Channels, Status Variables, Parameters, Shift Lights and Alarms, Trigger Commands, Icons Manager, Display, SmartyCam Stream, and CAN Output. The "Shift Lights and Alarms" menu is open, showing a configuration panel. At the top of this panel, there are two radio buttons: "Use for predictive time" (unselected) and "Use as gear shift lights" (selected). Below this is a table for configuring shift lights:

Gear	Shift Light 1	2	3	4	5	6
All	9000	9200	9400	9600	9800	10000

Below the table is a checkbox for "Activate Simulation" which is unchecked. In the center of the interface is a preview of a digital instrument cluster. The cluster displays a tachometer scale from 0 to 5 RPM, a speedometer showing 195 km/h, an oil pressure gauge showing 4.2 bar, and a lap timer showing 1:18:35. The text "GPS: GOOD" and "THUNDERHILL LONG" is visible at the bottom of the cluster. Below the cluster is a table for configuring alarms:

Event	Alarm
<input checked="" type="checkbox"/> Water	LED: 1

At the bottom of the alarm configuration area, there are buttons for "Add New Alarm", "Import Alarm", and "Export Alarm". A status bar indicates "33 alarms currently available".

5.2.5 – Math channels configuration

To create math channels; available options are:

- **Bias:** considering a relation between two mutually compatible channels it computes which one is prevailing (typically used for suspensions or brakes);
- **Bias with threshold:** it needs the user to set a threshold value for the considered channels; once these threshold are both exceeded the system makes the calculation;
- **Calculated gear:** it calculates the gear position using engine RPM and vehicle speed
- **Precalculated gear:** it calculates the gear position using Load/Shaft ratio for each gear and for the vehicle axle too
- **Linear correction** typically used when a channel is not available in the desired format or if it is wrongly tuned and cannot be tuned again
- **Simple operation:** to add or subtract from a channel value a constant value or another channel value
- **Division integer:** To get the integer part of the division
- **Division Modulo:** to get the remainder part of the division
- **Bit composed:** to compose 8 flags in a bit-field measure.

Each option asks the user to fill in a proper panel.

The screenshot shows the RaceStudio3 (64 bit) interface. The 'Math Channels' tab is active, and the 'Add Channel' button is highlighted with a red box. A dialog box titled 'Select a Mathematical Channel' is open, displaying a list of channel options with their descriptions and formulas.

Channel	Description
Bias	To calculate the bias of two channels VALUE = CH1 / (CH1 + CH2)
Bias with Thresholds	To calculate the bias of two channels only if they are greater than specified values VALUE = CH1 / (CH1 + CH2) [if both thresholds are exceeded, else 0]
Calculated Gear	To calculate the gear position from engine rpm and vehicle speed
Precalculated Gear	To calculate the gear position from engine rpm and vehicle speed, specifying the gear ratio for each gear and the axle ratio
Linear Corrector	To multiply a measure by a factor then add an offset value VALUE = (a * CH) + b
Simple Operation	To add to or subtract from a channel value a constant value or another channel value e.g. VALUE = (CH1 + CH2)
Division Integer	To get the integer part of the division VALUE = Integer(CH / a)
Division Modulo	To get the remainder part of the division VALUE = CH % a
Bit Composed	To Compose 8 flags in a bit-field measure VALUE = f1 + f2*2 + f3*4 + f4*8 + f5*16 + f6*32 + f7*64 + f8*128

5.2.6 – Status variables configuration

Status Variables are internal math channels that can have only two different values: 1 (TRUE) or 0 (FALSE). They may be useful for simplifying complex configurations, where it is required to evaluate if to activate alarms, LEDs, Icons etc..

Let us explain with an example. We would like to turn ON a LED and an Icon when Water temperature reaches 100°C and the RPM are higher than 2000. Instead of defining the same logic for managing the icon and for managing the LED, we could define a Status Variable, Water Temp Alarm and link Icon and LEDs to this variable. In this case we could define:

- Water Temp Alarm is High when:
 - Water Temp is higher than 100°C and
 - RPM is greater than 2000.

And use Water Temp Alarm for managing Icons and LEDs.

As you may see, the Status Variables are more useful when the logic to be evaluated is complex and involves different channels. In order to define a Status Variable enter the proper TAB.

The screenshot shows the RaceStudio3 (64 bit) interface. The 'Status Variables' tab is selected, showing '35 variables currently available' and a 'Preview Area'. A dialog box titled 'Create New Status Variable' is open, allowing the user to define a new variable. The variable name is 'Water Temp Alarm', the frequency is '50 Hz', and the 'add to device logged channels' checkbox is checked. The logic is defined as 'is TRUE when All of the following conditions are true: WaterTemp greater than 100.0 C and RPM greater than 2000 rpm. else is FALSE'.

The Status variables can be used as any other channel, so they may be seen online, transmitted to the CAN stream, recorded, used for triggering a command or for turning ON a LED or an Icon.



Mousing over the Status Variable a summary panel appears on the right as shown here below.

The screenshot shows the RaceStudio3 (64 bit) 3.53.18 interface. The 'Status Variables' tab is active, displaying a table with the following data:

Status Variable	Freq	Mem
<input checked="" type="checkbox"/> Water Temp Alarm	50 Hz	<input checked="" type="checkbox"/>

Below the table is an 'Add New Variable' button and a text box indicating '33 variables currently available'.

The summary panel on the right for 'Water Temp Alarm' contains the following fields:

- Name: Water Temp Alarm
- Freq: 50 Hz
- add to device logged channels
- is TRUE when this condition occurs
- WaterTemp greater than C 100.0

5.2.7 – Parameters configuration

To set the beacon.

Mousing over the question marks a pop up message explains the working mode of **Lap Detection**:

- **GPS Beacon** (needs an optional GPS09 Module):
 - hold lap time for: the time period for which lap time is shown on your MX Strada series display
 - the track width: width that will be considered for any GPS point you set
- **Optical beacon (connected via CAN not recommended)**:
 - ignore additional lap signal for: after receiving an Infrared lap signal, the receiver does not detect another signal for the time period fixed in the related box. This is useful if more lap transmitters are placed nearby on the side of the track. Needs an optional IR lap receiver to work.

The screenshot shows the 'Lap Detection' configuration window in RaceStudio3. The window title is 'RaceStudio3' and it has a standard Windows-style title bar. The menu bar includes 'Channels', 'ECU Stream', 'CAN2 Stream', 'CAN Expansions', 'Math Channels', 'Status Variables', 'Parameters', 'Shift Lights and Alarms', 'Trigger Commands', 'Icons Manager', 'Display', 'SmartyCam Stream', and 'CAN Output'. The 'Parameters' tab is selected. The 'Lap Detection' section is active and contains the following settings:

- Hold lap time for:** 8 sec (with a question mark icon). A callout box explains: "This is the number of seconds that the lap time is held static on the display before resuming a dynamic views such as: predictive, current or running lap time".
- GPS Beacon:** Selected radio button. Below it, **Track Width:** 33 ft (with a question mark icon). A callout box explains: "This is the width that will be considered for any GPS points set (i.e. the width of the start/finish line)".
- CAN Optical Beacon:** Unselected radio button. Below it, **Ignore additional lap signal for:** 8 sec (with a question mark icon). A callout box explains: "After receiving an IR lap signal, the receiver cannot receive another signal for how ever many seconds specified. This is used to ignore additional signals from other possible beacon sources".

5.2.8 – Shift Lights and Alarms configuration

To set shift lights (on top) and alarm LEDs (bottom) of your MX Strada series. Any event you have already configured (water temperature status variable in this case) is shown bottom of the software view.

The screenshot shows the RaceStudio3 software interface with the 'Shift Lights and Alarms' configuration window. The window has two radio buttons: 'Use for predictive time' (unselected) and 'Use as gear shift lights' (selected). Below these is a table for configuring shift lights:

Gear	Shift Light 1	2	3	4	5	6	7	8	9	10	
All	8200	8400	8600	8800	9000	9200	9400	9600	9800	10000	⚙️

Below the table is a checkbox for 'Activate Simulation'.

In the center of the workspace is a simulated instrument cluster for the MX Strada series, showing a tachometer with a needle at 5500 RPM and a gear indicator at 4. The cluster is surrounded by six LED indicators labeled LED 1 through LED 6.

At the bottom of the configuration window is a table for configuring alarms:

Event	Alarm	
<input checked="" type="checkbox"/> Water		⚙️

Below the table are buttons for 'Add New Alarm', 'Import Alarm', and 'Export Alarm'. A status bar indicates '33 alarms currently available'.

On top MX Strada series shift lights working mode can be set. Available options are:

- shift lights, for helping in changing gear and
- predictive time: for easily understanding if the current lap is faster or slower than the reference lap.

Use as gear Shift Lights To use the LED bar as shift lights click the icon (⚙️) for setting the parameters. Configure:

- at which RPM value the single LED turns ON
- the sequence mode of the LEDs enabling the desired option:
 - a LED stays on if its threshold is exceeded
 - a LED stays on until another LED with higher threshold turns on or
- link the shift lights to the engaged gear enabling the related checkbox;

Shift Lights Options

Choose a sequence mode of shift lights

ALED stays on if its threshold is exceeded
 ALED stays on until another LED with higher threshold is turned on

Choose the engine rpm channel: RPM

Gear dependent shift lights Max gear number: 6

Choose the gear channel: Gear

Select colors and threshold values for shift lights:

Gear	Shift Light 1	2	3	4	5	6	7	8	9	10
6	8200	8400	8600	8800	9000	9200	9400	9600	9800	10000
5	8200	8400	8600	8800	9000	9200	9400	9600	9800	10000
4	8200	8400	8600	8800	9000	9200	9400	9600	9800	10000
3	8200	8400	8600	8800	9000	9200	9400	9600	9800	10000
2	8200	8400	8600	8800	9000	9200	9400	9600	9800	10000
1	8200	8400	8600	8800	9000	9200	9400	9600	9800	10000

Use for predictive time. Click the icon (⚙️) for setting the parameters.

In this case the LEDs colour are fixed in:

- Green if the lap time is improving
- Red if the lap time is worse than the reference lap

The threshold at which one LED is turned ON can be customized. Assuming “0.10 sec” is fixed and the lap time is improving of 0.30 sec toward the reference lap, MX Strada series will switch on 3 LEDs green; if, on the contrary, the lap time is worsening the LEDs will switch on red.

Please note: this option only works if an optional GPS Module is connected.

The screenshot displays the RaceStudio3 interface for configuring shift lights and alarms. The 'Shift Lights and Alarms' tab is active, and the 'Use for predictive time' radio button is selected. A table at the top shows the configuration for LED bars:

Channel for LED-bars	Incremental time per LED	Better	Worse
~ Ref Time	0.10 sec		

Below this table, there is an 'Activate Simulation' checkbox and a central image of a motorcycle dashboard with six LEDs labeled LED 1 through LED 6. Underneath the dashboard is an 'Alarm' table:

Event	Alarm
<input checked="" type="checkbox"/> Water	

At the bottom, a 'Predictive Time Bar Options' dialog box is open, allowing for further customization:

- Choose a sequence mode of shift lights:
 - ALED stays on if its threshold is exceeded
 - ALED stays on until another LED with higher threshold is turned on
- Predictive Time Increment per LED: (sec)
- Better Time LED Color:
- Worse Time LED Color:

Create and set MX Strada series alarm

To create a new alarm press “Add New Alarm” and the related panel shows up. It allows to set alarms for the connected CAN expansions too as shown below.

The screenshot displays the RaceStudio3 interface for configuring an MX Strada series alarm. The main window shows the 'Shift Lights and Alarms' tab, which includes a table for LED configurations and a central dashboard preview.

Channel for LED-bars	Incremental time per LED	Better	Worse
- RefTime	0.10 sec		

Below the table, there is an 'Activate Simulation' checkbox and a central dashboard preview showing various vehicle metrics like RPM (5500), Water Temp (90°C), and Oil Pressure (4.2 bar). Six LED indicators (LED 1 to LED 6) are positioned around the dashboard.

At the bottom, an 'Event' table shows a 'Water' event with a priority icon. Below this is an 'Add New Alarm' button, which is highlighted with a red box. To the right of this button, it indicates '33 alarms currently available' and provides 'Import Alarm' and 'Export Alarm' options.

The 'Create New Alarm' dialog box is open, showing the following configuration:

- Description:** [Empty field]
- If:** All of the following conditions are true:
- Condition 1:** Oil Pressure greater than 0 bar
- Alarm actions in MXS 1.2 Strada:** Message [Insert message text]
- Until:** condition no longer met
- Alarm actions in Steering Wheel 3:** Popup Message timed [Insert message text] until alarm end
- Until:** condition no longer met
- Alarm actions in RIO 02a or RIO 02b:** Output 1 Open Circuit
- Until:** condition no longer met

The dialog box includes 'Save' and 'Cancel' buttons at the bottom right.

To set the new alarm:

- define the Alarm name filling in “Description” box (Oil Temp in the example)
- a combination of Alarm conditions can be set: choose if the conditions are to be ALL valid or just one of them
- decide which action is to be triggered among displaying a message or a timed popup message, display a measure, switch a LED on or activate an output signal (CAN output page, see paragraph 5.2.13) and repeat this setting for all CAN expansions you want to trigger an action
- decide the alarm ending condition among: condition no longer met, the device is turned off, a button is pushed or data are downloaded
- “+” buttons right of the panel are to add new alarms (the top one) or to add new actions to an alarm (bottom one)
- when all operations have been performed press “Save” in “Create New Alarm” Panel and the software comes back to “Shift Lights and Alarm” page.

In the example below user decides that when oil temperature is greater than 130°C:

- MX Strada displays the oil temp measure red
- Steering Wheel 3 displays “Oil Temp message”
- for both ending condition is “condition is no longer met”.

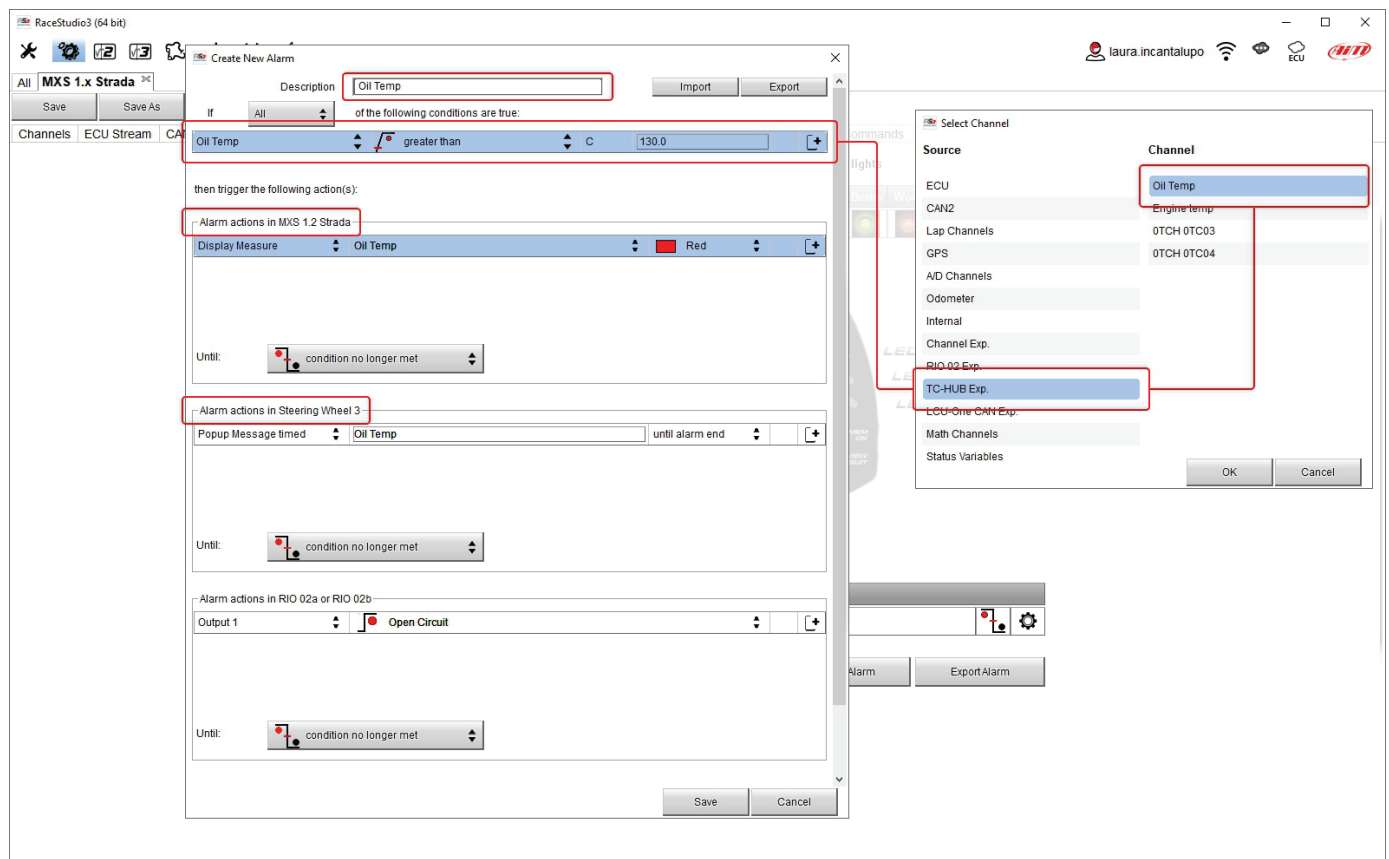

5.2.9 – Trigger commands configuration

“Trigger Command” executes some specific actions on MX Strada series.
The commands available up to now are:

- Display Page Command
- Display Button command
- reset alarms whose ending condition is “a button is pushed”
- none

To add a new command.

- Press “Add new Command”
- a combination of conditions are allowed for setting a Trigger Commands and it is possible to decide if the conditions are to be ALL valid or just one of them.

The screenshot illustrates the configuration of a trigger command in RaceStudio3. The main interface shows a table with columns for 'Event' and 'Alarm'. Below this table, there is a section with buttons: 'Add New Command', '32 commands currently available', 'Import Command', and 'Export Command'. The 'Add New Command' button is highlighted with a red box. A dialog box titled 'Create New Output Command' is open, showing a condition 'Gear' selected from a dropdown menu. Another dialog box titled 'Select Channel' is open, showing 'Gear' selected from the 'Channel' column. Red lines connect the 'Add New Command' button to the 'Create New Output Command' dialog, and the 'Gear' condition in the dialog to the 'Select Channel' dialog.

- decide the action to be performed

In the example below when reverse gear is engaged the first camera is displayed.

The screenshot shows the RaceStudio3 interface with the 'Trigger Commands' tab selected. A 'Create New Output Command' dialog box is open, showing the configuration for a new command. The dialog has the following fields and options:

- Description:** Parking Assistance
- If:** All of the following conditions are true:
- Condition:** Gear equal to R
- then trigger the following action(s):**
 - Command actions in MXS 1.2 Strada: First Camera Input
 - Command actions in Steering Wheel 3: commands not yet associated to this event
- Buttons:** Save (highlighted with a red box), Cancel, Import, Export

In the Trigger Commands summary page, trigger command can be modified/deleted right clicking on the setting icon placed right of the trigger row.

The screenshot displays the RaceStudio3 (64 bit) 3.54.01 interface. The 'Trigger Commands' tab is active, showing a table with columns for 'Event' and 'Alarm'. The table lists three entries: 'Water', 'Oil Temp', and 'Parking Assistance' (with 'First Camera Input' as the alarm). A gear icon is visible next to the 'Parking Assistance' row. Below the table are buttons for 'Add New Command', 'Import Command', 'Export Command', and 'Delete Selected Alarm'. A red line connects the gear icon to the 'Edit Selected Alarm' button.

The 'Modify Output Command' dialog box is open, showing the configuration for the 'Parking Assistance' event. It includes a 'Description' field with 'Parking Assistance', an 'If' dropdown set to 'All', and a condition 'Gear' set to 'equal to' 'R'. The 'then trigger the following action(s):' section shows 'Command actions in MXS 1.2 Strada' with 'First Camera Input' selected. The 'Command actions in Steering Wheel 3' section shows 'commands not yet associated to this event'. 'Save' and 'Cancel' buttons are at the bottom.

5.2.10 – Icons manager configuration

The “Icon” is a set of images, each one of them to be shown on each page as desired, that depend on a fixed condition that, when exists, triggers the proper image. For example:

- the first image has to be shown when the signal Turn Right is TRUE
- the second when the signal Turn Left is TRUE
- the third when the signal Hazard is TRUE
- the fourth when no signal is TRUE

Not all display pages offer the possibility to show icons but our technicians are working for offering more pages with this feature.

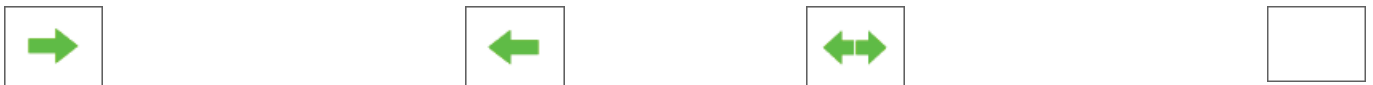

To configure an Icon

- press “Add New Icon”
- “Manage Icon” panel shows up (select “Predefined” tab to see the available default icons)
- press “Select” to see the panel showing all images
- select the image you want to set
- the software comes back to “Manage Icon” panel
- set the image conditions according to the channel they are related to

The screenshot shows the RaceStudio3 interface with the 'Icons Manager' tab selected. The main window displays '31 icons currently available' and a 'Preview Area'. A 'Manage Icon' dialog box is open, showing the configuration for 'lco_1' with the condition 'Oil Pressure greater than 0 bar'. A 'Select a icon to show' dialog is also open, showing a grid of predefined icons, with a fuel pump icon highlighted.

The "Icons page" shows a summary of the selected icons. If you mouse over any Icon, a panel with all the information appears.

Icon can be edited/selected pressing .

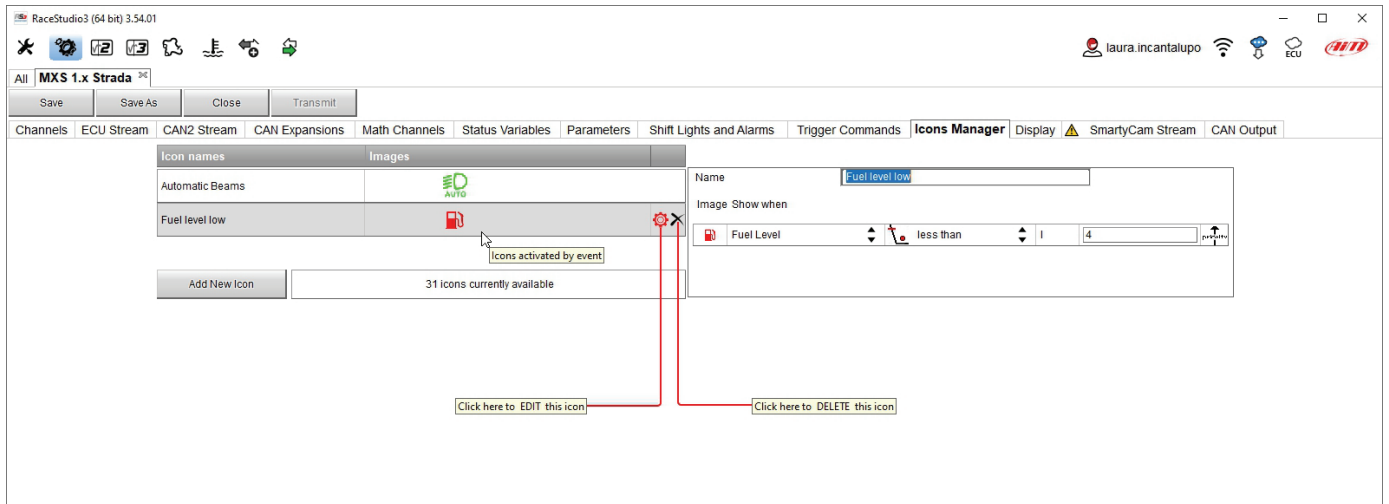

It is also possible to custom colourize the available icons or to create new ones. In this second case they have to be 64x64 pixels dimensions .png format, you need to create and upload it through windows explorer. To colour an icon, once pressed “Add Icon” and selected “Coloring” tab you simply select the icon to colour and the colours panel shows up. Selecting the desired colour the icon is coloured.

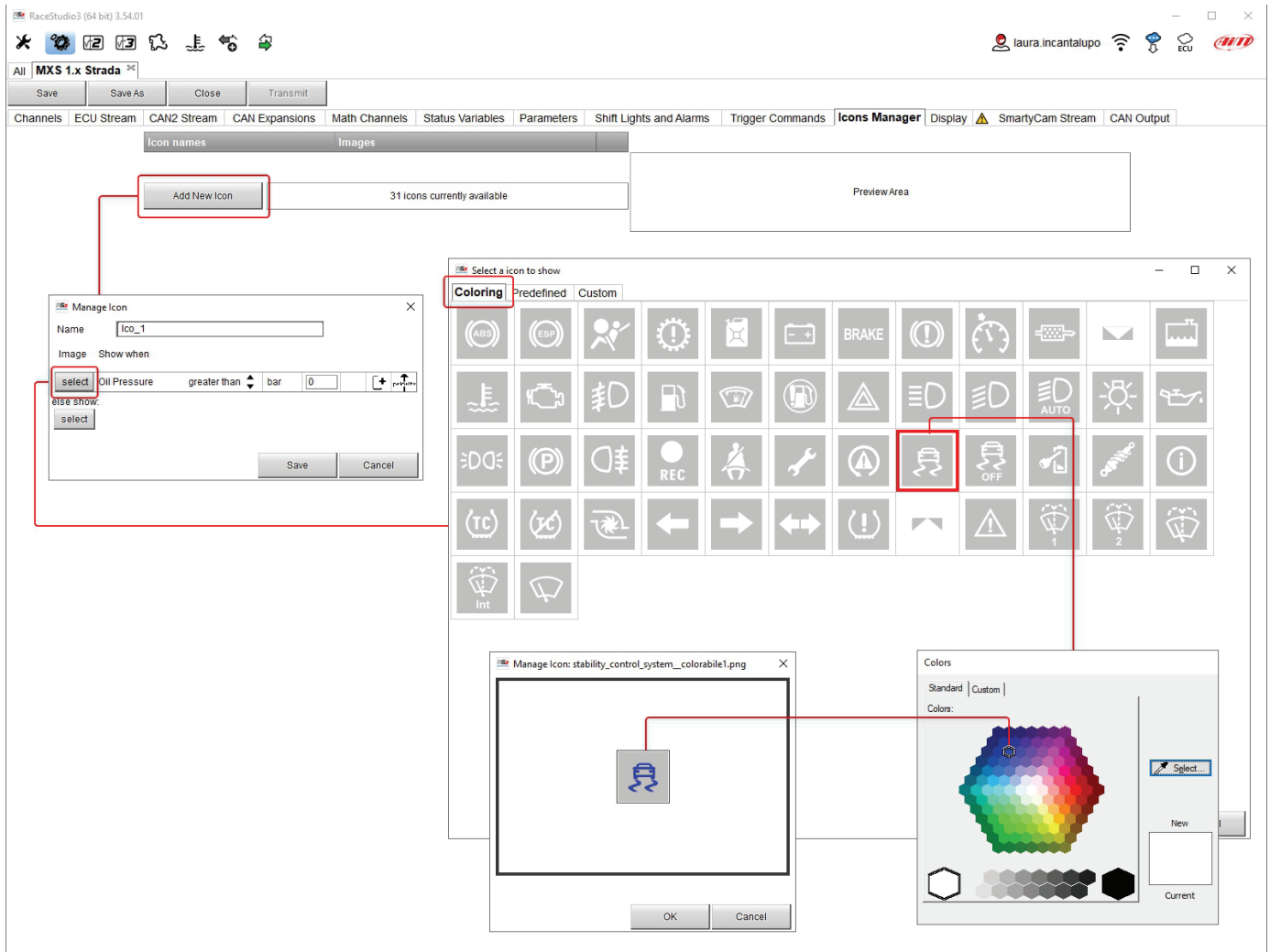

5.2.11 – Display configuration

MX Strada series can have up to eight pages to be set via software.

- enter “Display” tab
- a panel shows up: select a display page (in the example a page with icons bar has been chosen)
- select the page and press “OK”
- repeat the operation for the number of pages to set

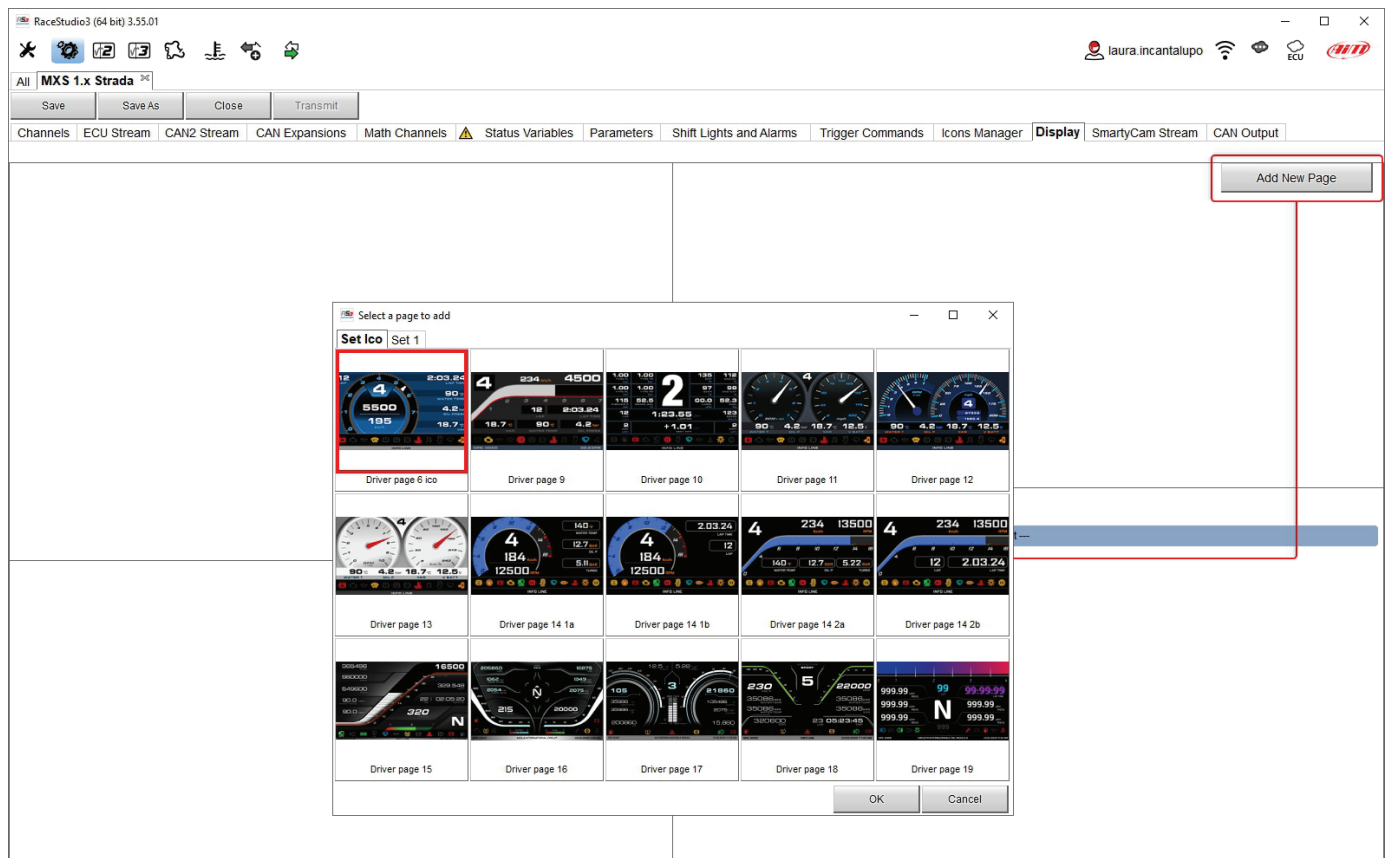



When the page has been selected two setting panels appear bottom of the page:

- on the left a panel that shows as many rows as the fields to be set
- on the right a panel that shows the channels group that can be set in that field and all the channels in it included; drag and drop the channel to set in the desired field or double click on it
- if more display pages have been added a label top of the tab indicates the one in use as highlighted here below.

The screenshot shows the RaceStudio3 (64 bit) 3.55.01 interface. The main dashboard displays various metrics: Lap Number (99999), Lap Time (99:99:99), Predictive Time (99:99:99), +/- Ref Time (-9.99), and Steering Angle (9999 deg). Below the dashboard is an 'INFO LINE' table with columns for field names and their corresponding values or units.

Field	Value/Unit
LAP	Lap Number
Sats Number	Sats Number
RPM	RPM 18000
Gear	Gear
Oil Temp	Oil Temp C
Lap Time	Lap Time
Predictive Time	Predictive Time
+/- Ref Time	+/- Ref Time
Steering Angle	Steering Angle deg

On the right, the 'Channel Groups' and 'Channels' panels are visible. The 'Channel Groups' list includes ECU, CAN2, Lap Channels, GPS, AID Channels, Odometer, Internal, Channel Exp., RIO 02a Exp., TC-HUB Exp., LCU-One CAN Exp., Math Channels, Status Variables, and --- NOT SET ---. The 'Channels' list includes RPM, SpeedVeh, SpeedFL, SpeedFR, SpeedRL, SpeedRR, Gear, WaterTemp, TurboBoost, TCSBrakeEvent, TCSEngEvent, StabCtrlTaltal, StabCtrlMTXT, TyreRMile, and FuelLevelMean. A 'Digit Font' panel shows 'MicrogrammaDBolExt' with a font size of 54 and alignment set to 'right'.

5.2.12 – SmartyCam stream setting

MX Strada series can be connected to AiM SmartyCam 3 cameras both Sport and Dual to show the desired data on SmartyCam video. **SmartyCam 3 Sport and SmartyCam 3 Dual default stream configuration** works the same way as for the following explanation. To set each channel:

- click on it and a setting panel shows up
- it shows all channels and/or sensors that fits the selected function
- in case the desired channel or sensor is not in the list enable “Enable all channels for functions” checkbox and all channels/sensors will be shown
- to select a specific channel belonging to a channel group double click on it and select the desired data source and press “OK” as shown here below.

The screenshot shows the RaceStudio3 interface with the 'SmartyCam 3' configuration window open. The 'Default' radio button is selected, and the 'Advanced' radio button is unselected. The checkbox 'Enable all channels for functions' is checked. A table lists various channels with 'Oil Temp' selected. A 'Select Channel' dialog box is open, showing 'Oil Temp' selected in the 'Channel' list.

ID	SmartyCam Function	Channel
CC01	Engine RPM	RPM
CC02	Speed	GPS Speed
CC03	Gear	Gear
CC04	Water Temp	WaterTemp
CC05	Head Temp	--- Not Set ---
CC06	Exhaust Temp	--- Not Set ---
CC07	Oil Temp	Oil Temp
CC08	Oil Press	Oil Pressure
CC09	Brake Press	FR Brake Pr
CC10	Throttle Pos	--- Not Set ---
CC11	Brake Pos	--- Not Set ---
CC12	Clutch Pos	--- Not Set ---
CC13	Steering Pos	Steering Angle
CC14	Lambda	0Lambda
CC15	Lateral Accel	LateralAcc
CC16	Inline Accel	--- Not Set ---
CC17	Fuel Level	--- Not Set ---
CC18	Battery Voltage	Battery
CC19	Vertical Accel	--- Not Set ---

SmartyCam 3 Dual only allows the user to configure an **advanced** streaming. To do so:

- press "Add new payload"
- set The related panel and press "OK"
- set all bytes double clicking on each byte field

Once the payload set it is possible to import/export it using the related buttons.

Please note: SmartyCam 3 advanced streaming configuration works exactly like CAN output one (paragraph 5.2.13)

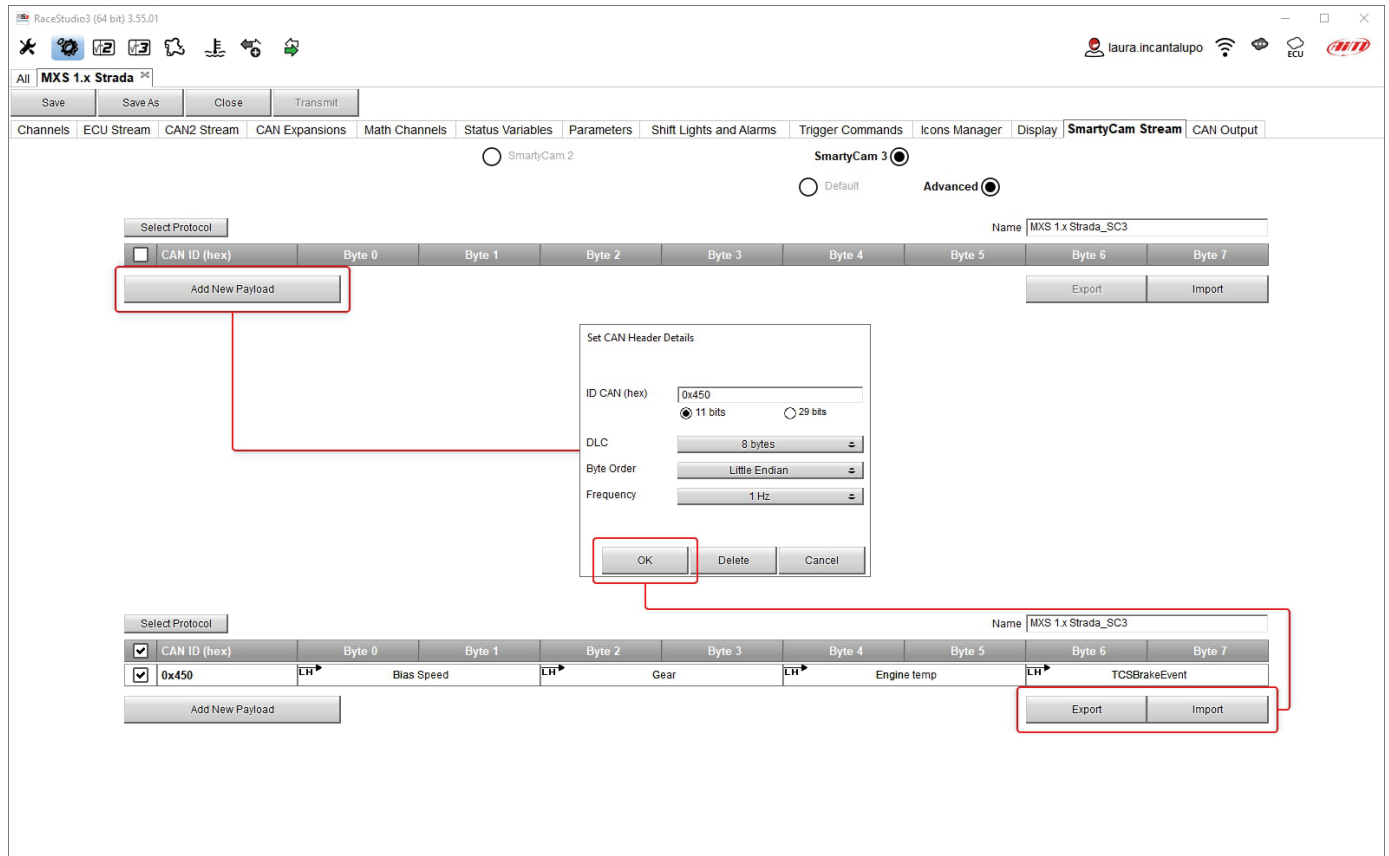

5.2.13 – CAN Output configuration (expert users only)

Please note: this function is for expert users only.

Here it is possible to create payloads for both MX Strada CAN1 and CAN2 outputs
To add a payload:

- press “+Add new Payload” and “Set CAN Header details” panel appears;
- fill in ID CAN (hex) and select among these options:
 - 11 bits (normal address)
 - 29 bits (extended address)
- select the payload max bytes number (DLC), available options are from 1 to 8 bytes
- select the byte order according to the used processor, available options are:
 - Little endian for Intel processor
 - Big Endian for Motorola processor
- set the sampling frequency among: 1,2, 5, 10 or 20 Hz
- press “OK” to save the payload

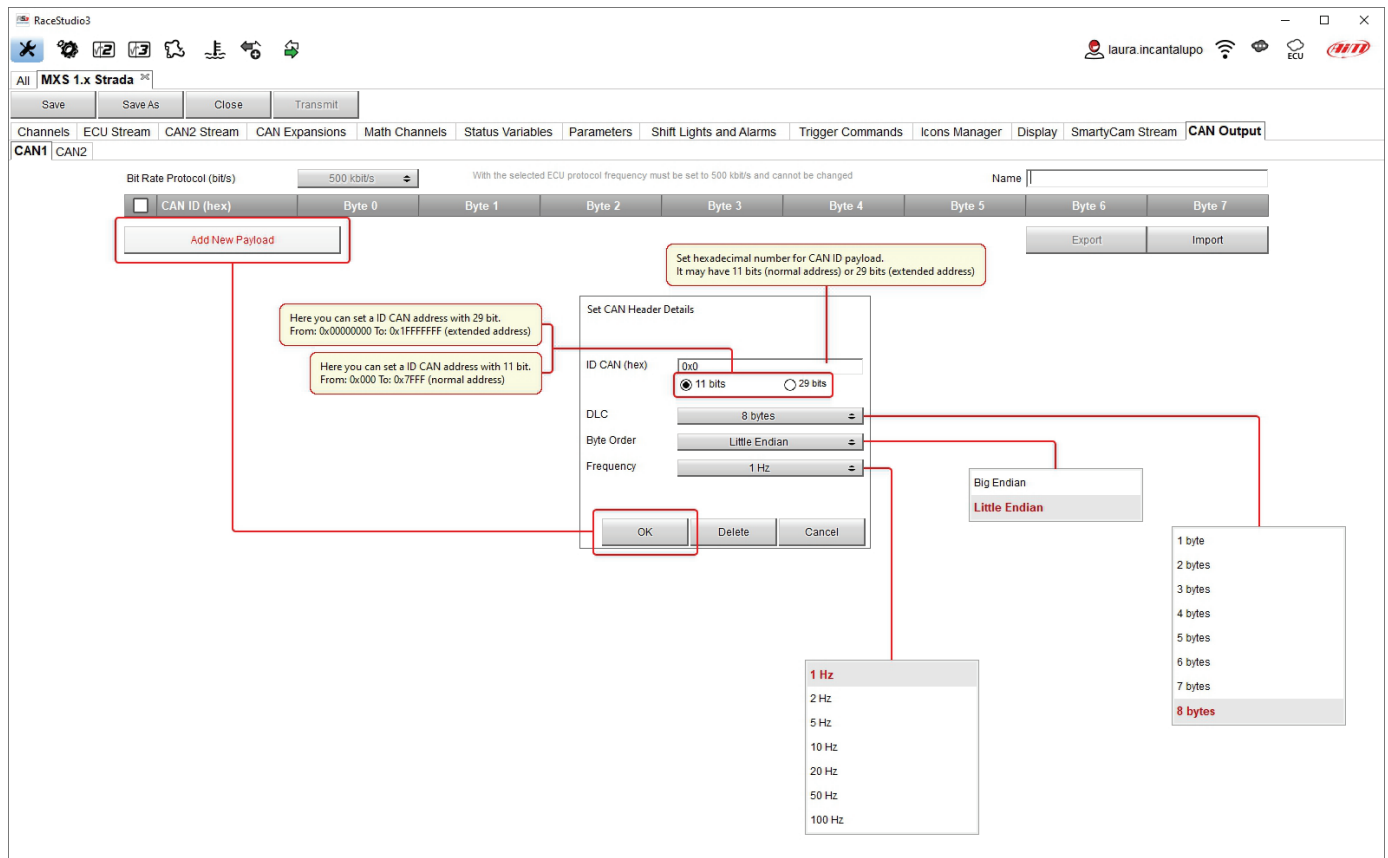

When the payload has been added it need to be set. To do so:

- double click on the Byte to set
- select the channel to set in that field
- set any additional parameter if needed
- press OK to save the payload setting

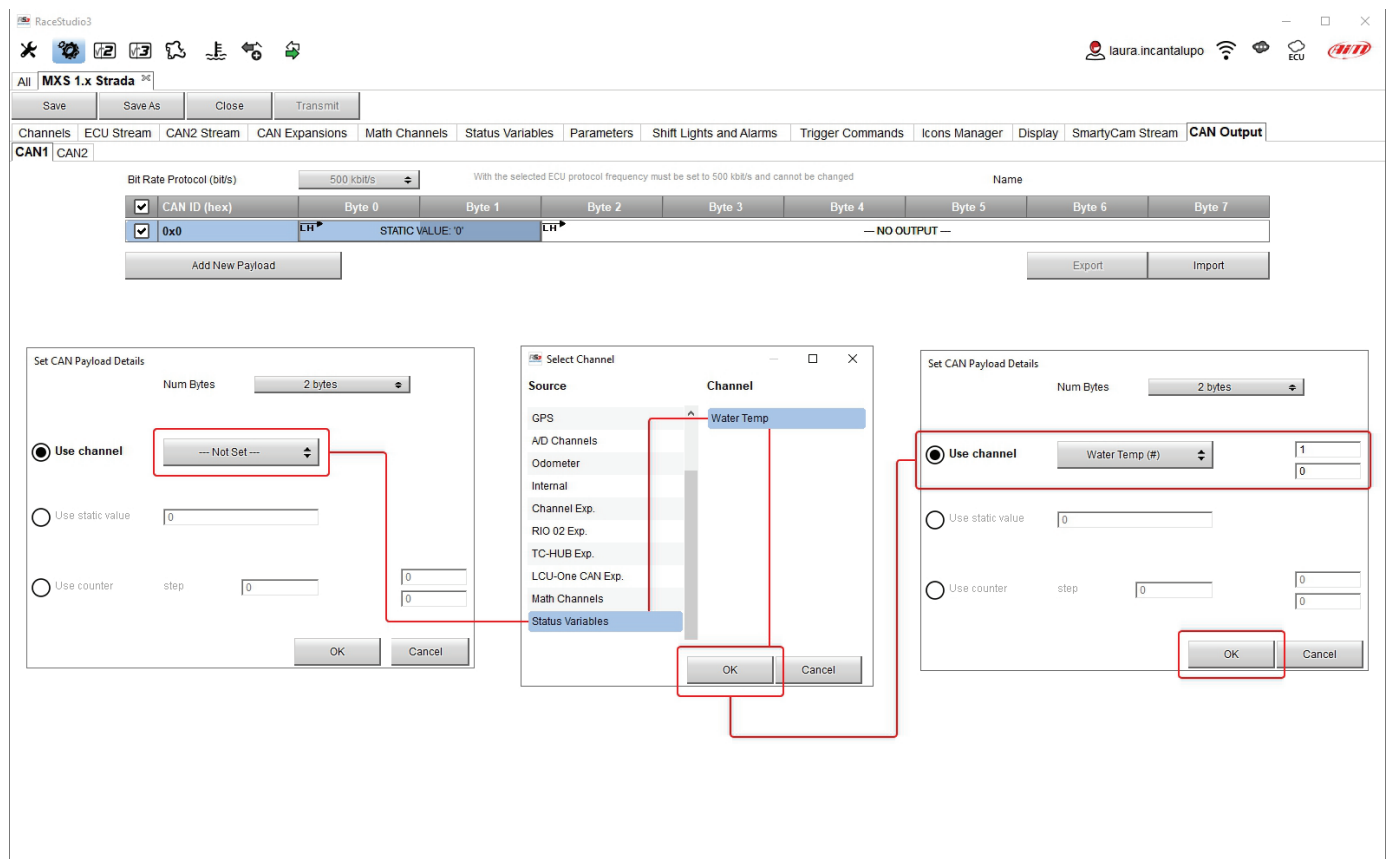

All payloads can be imported and exported to be used for other devices

When all channels set your configuration is finished:

- press "Save" on the page top keyboard
- press "Transmit" to transmit the configuration to MX Strada series



5.2.14 – Transmitting the configuration to MX Strada

As said before: **MX1.3 strada loggers do not support thermocouple sensors except through a TC Hub** so if you set these sensors you need to add a TC Hub to AiM network

For this reason if your configuration includes one or both of these features and no TC Hub is connected when you transmit the configuration to the logger the panel shown below on the left is prompted. When the configuration is transmitted a confirmation message is prompted (right image below)

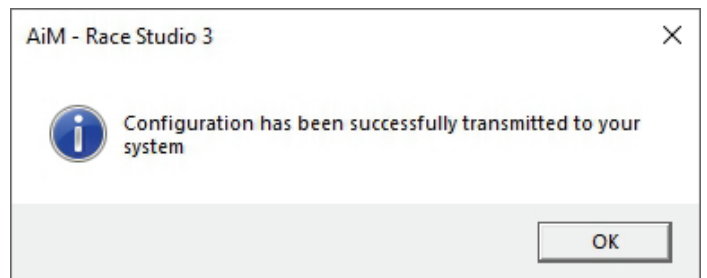
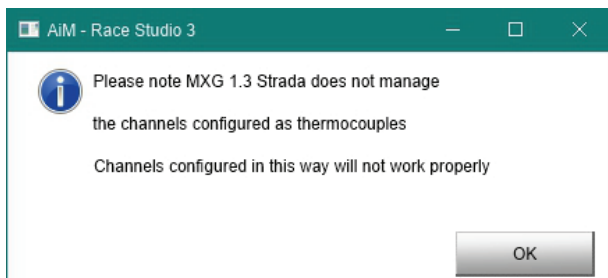

5.3 – Managing a track on MX Strada with Race Studio 3

With Track Manager function of Race Studio 3 tracks can be created, deleted and modified transmitted and received to/from MX Strada series. Press “Tracks” icon.

Please remember: an optional GPS08 Module is needed.



The main page is divided in three columns; on the **left**:

- on top, the filters that allow to collect many tracks following customized criteria; by default, all tracks are shown.
- bottom left, the connected devices

The column **in the middle** shows:

- on top a fast search bar, that allows to select the tracks which satisfy your personal research criteria; pressing “?” a tooltip explains research criteria (highlighted in red below), to say:
 - long name is the name in bold in each track box
 - short name is the track name shown on the display of MX Strada series and shown top right of each track box
 - track city is the name of the city the track is located in
- all the tracks listed in Race Studio 3 database. It automatically updates at start up if a connection to the Internet is available.

The column on the **Right** shows:

- the datasheet of the track you are mousing over.



When MX Strada series is connected it is shown on the left bottom part of the page as said before. Clicking on it all the tracks it contains are shown in the right column of the page.

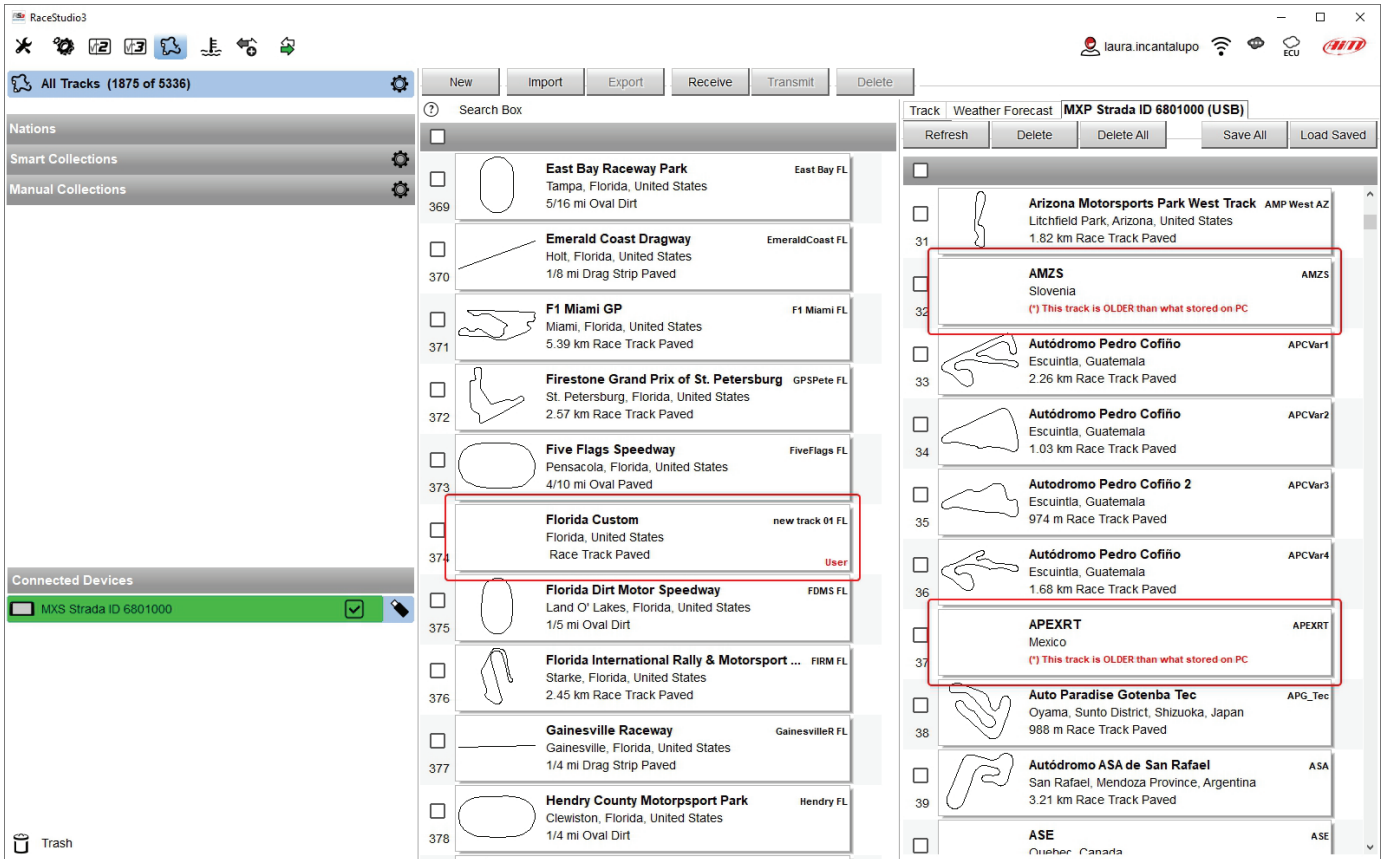

Tracks created by the user are labelled "User" and if the track stored in MX Strada series dash is different from the one stored on AiM database this is notified as shown here above.

The page keyboards are used to manage the tracks. The keyboard above the software database allows to:



- **New:** create a new track
- **Import:** import one or more tracks stored in the device or in another external device
- **Export:** export one or more tracks to a specific PC folder or to another peripheral device
- **Receive:** receive from the connected device the tracks user created (if no device is connected the button is disabled)
- **Transmit:** transmit one or more tracks from the PC to the connected device (if no device is connected the button is disabled)
- **Delete:** delete one or more tracks from Race Studio 3 database

The keyboard you find above the dash database allows to:

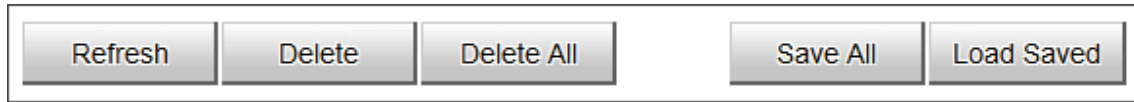

- **Refresh:** refresh the track list stored in the connected device
- **Delete:** delete one or more tracks from the device memory
- **Delete All:** delete all tracks stored in the device memory
- **Save all:** save all the tracks stored in the device; it creates a zip file that can be loaded to another AiM device
- **Load Saved:** load the tracks previously saved in the device memory

Since the software is constantly updated, may be other information or features will be available soon. Please check our website www.aim-sportline.com, documentation area, software/firmware section "Track Manager" manual.

5.4 – ECU Driver builder



Using CAN Driver builder function it is possible to create a new driver or to add a new driver for an existing manufacturer. **Please note: this Race Studio function is for expert users only.**

It is possible to add a new ECU Manufacturer and/or a new ECU model. To do so:

- press "New" on the top central keyboard
- "New Custom CAN Protocol" panel is prompted
- press "Add Manufacturer" to add a new Manufacturer and "Custom Protocol Manufacturer Manager" panel shows up
- Fill in the Manufacturer name ("John" in the example below) and press "OK"
- to add a new ECU Model for an existing Manufacturer just select the manufacturer and fill in "Edit new model name" box.

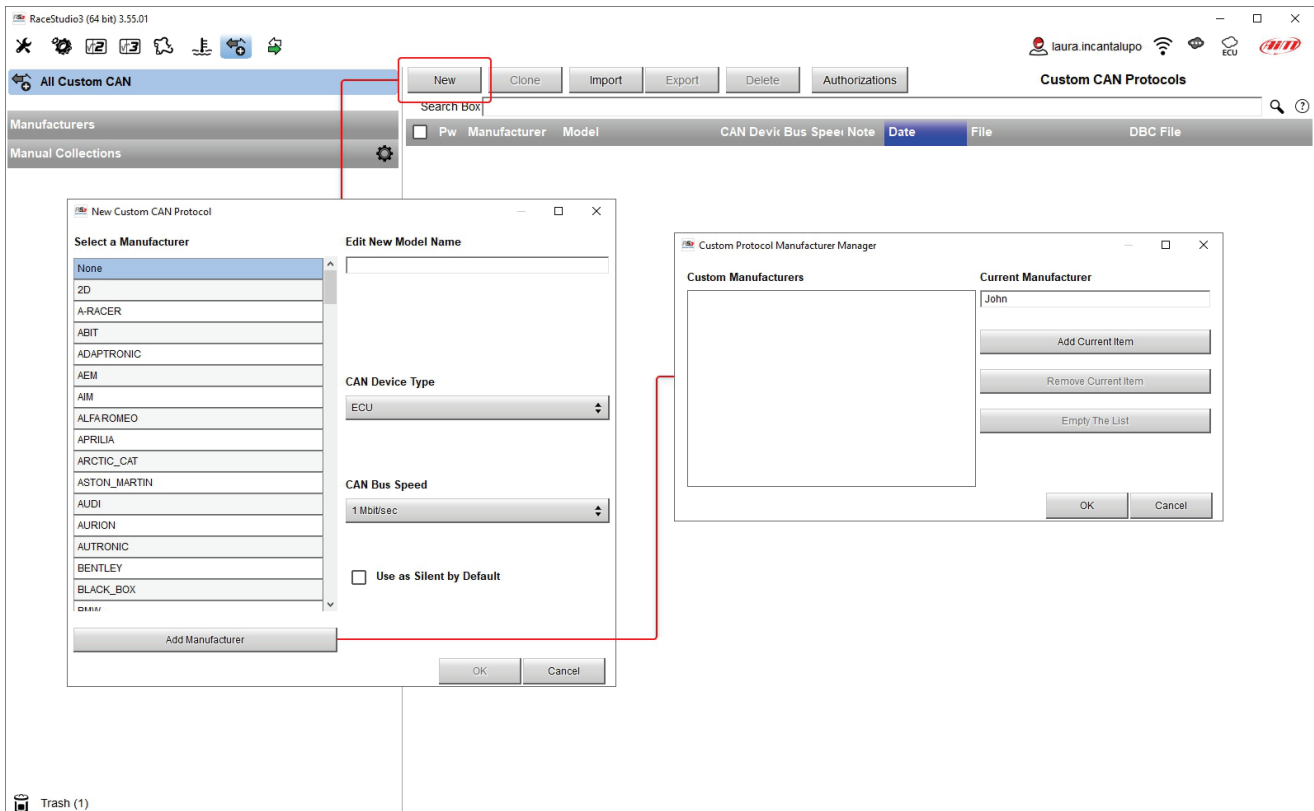

The software comes back to “New Custom CAN Protocol”:

- select the ECU Manufacturer previously created
- fill in the Model name in the panel top right box
- select the CAN Device type; available options are:
 - ECU
 - other CAN Devices
- select the CAN Bus speed; available options are:
 - 125 Kbit/sec
 - 250 Kbits/sec
 - 500 Kbit/sec
 - 1 Mbit/sec
- if the network features multiple devices we suggest to enable “Use as Silent by Default” checkbox
- Press “OK” and a new CAN Driver has been added

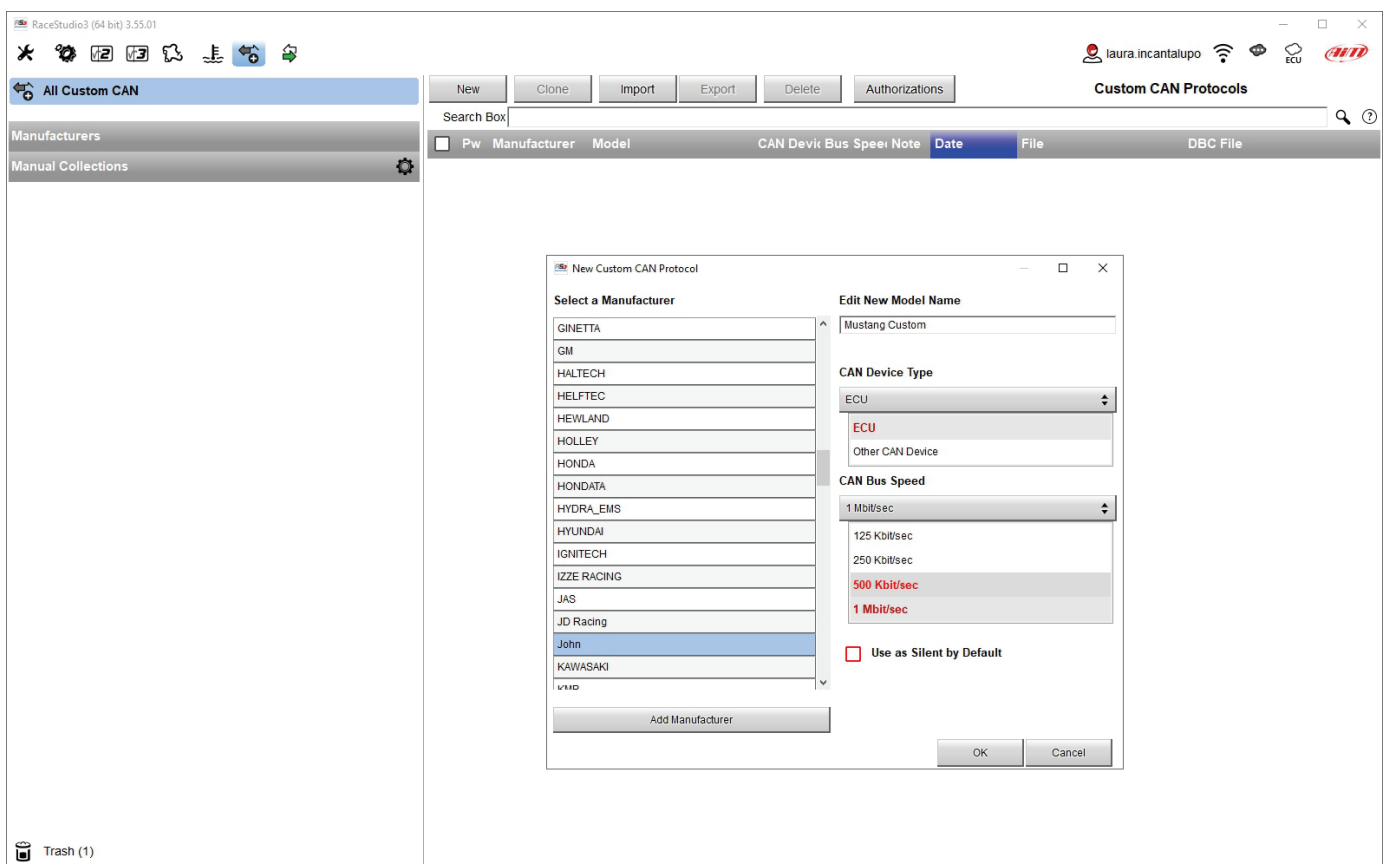

For further information about how to set the new CAN Driver refer to the CAN Driver builder user manual downloadable from our website www.aim-sportline.com, documentation area software/firmware section.

5.5 – The device window

The screenshot shows the RaceStudio3 software interface. The main window displays data for the device 'MXS Strada ID 6801000 (USB)'. The data is organized into several sections:

- Master:** A table showing various sensor readings:

RPM	0 rpm	Channel03	-101 mV	Channel07	-104 mV
LoggerTemp	38.0 C	Channel04	-104 mV	Channel08	-98 mV
Channel01	-111 C	Channel05	-107 mV	External Voltage	13.2 V
Channel02	-101 mV	Channel06	-102 mV	Luminosity	6 %
- Lap channels:** A table showing lap-related data:

Lap - Lap Number	0	Lap - Split Number	0	Lap Time	0:00.000
Lap - Run Number	0	Lap - Split Time	0:00.000		
- GPS 09 B - Serial 8901208:** A table showing GPS data:

GPS	GPS Good	GPS - Longitude	9.335441 E deg	GPS - Spd Accuracy	0.2 m/s
GPS - Altitude	198.03 m	GPS - Pos Accuracy	3.17 m	GPS - Speed	0.4 km/h
GPS - Latitude	45.537774 N deg	GPS - Sat Number	10		

At the bottom of the main window, there is a toolbar with several buttons and controls:

- Buttons for '1 2 3' (start/stop live measure stream from device).
- Buttons for 'CFG', 'A-Z', and 'Ch Ty' (sort by Configuration, Sort Alphabetically, Sort by Channel Type).
- Buttons for 'mV' (show also mV values) and a calibration icon (select a channel and perform its calibration).
- A button for 'Click to make my device blink'.
- A button for 'Click to perform autocalibration for all channels'.

Clicking the device, bottom left of the software page, the software enters device page. Top of the view are six buttons, some of whose change its function pressing it as explained in the above image.

The page is made up of different tabs here below listed.

- **Live Measures:** to check all device channels and force online values to:
 - start/stop live measures
 - sort the channel visualization as preferred: as managed by the firmware (sort by configuration), alphabetically, by channel type (they will be shown by device, channel type and measure type)
 - calibrate sensors that need the calibration
 - show the measure in Mv
- **Properties:** to name the device, fill in racer's and vehicle name or number, championship and venue type (generic or qualifying testing, warm up, race, test type)
- **Settings:** to set date and time as well as set the reference lap for predictive time
- **Tracks:** shows all tracks stored in MX Strada memory
- **Predictive reference lap:** here it is possible to manage the lap to be used as reference for predictive lap time calculation (see paragraph 5.5.4 for further information)
- **Counters:** to set/reset the device odometers
- **Logo:** transmit/receive the logo that shows up when switching the device on; supported image format are JPEG or BMP; always use the most recent Windows™ versions (Windows8 or Windows10) whose graphic libraries are more updated
- **Firmware:** to check or update MX Strada series firmware version.

5.5.1 – Live measures layer

Once the configuration has been transmitted “Live Measures” page shows ECU Channels too and some operations can be performed, like start recording and start/stop live measures as well as making the device blinking pressing the button top right of the page. This last operation is the easiest and quickest way to test PC-Device communication.

5.5.2 – Online value forcing

Device page Live measures tab features online measure value forcing, a very useful function that allows the user to simulate one or more channels value to test icons, alarms, power output and harnesses behaviour.

With reference to the configuration we created it is possible to verify if Water Alarm status variable works.

The set conditions (paragraph 5.2.6) are: water Temperature greater than 100 +RPM greater than 2000. To force these values:

- mouse over the value to force and click the setting icon
- a popup menu appears: select “Force Value” option and fill in the following panel

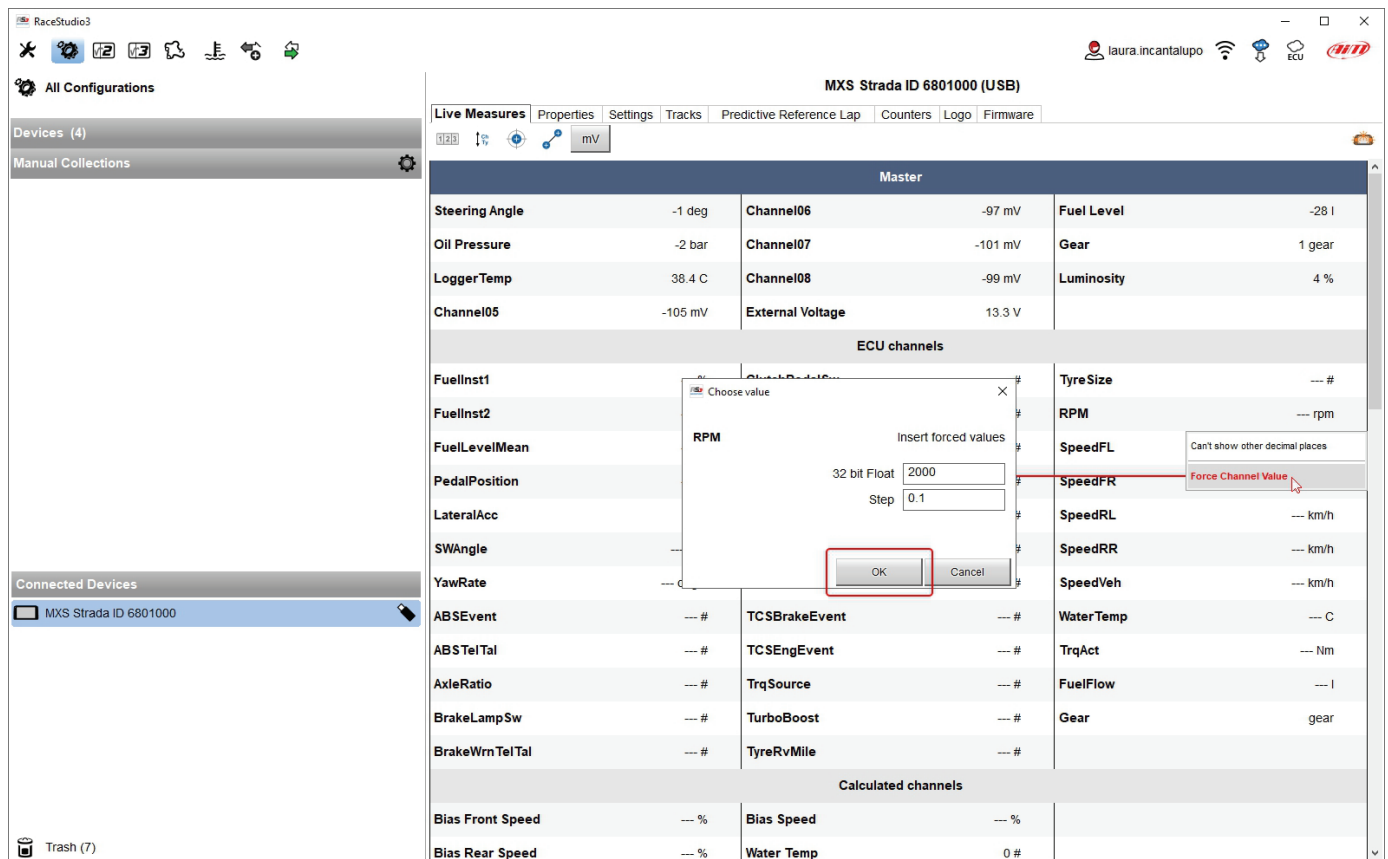

As shown in the image below, once the values have been forced they are shown right of the page hedged in red. With the two "+" and "-" lateral buttons it is possible to change the forced values.

The screenshot shows the RaceStudio3 interface with the following components:

- Left Sidebar:**
 - All Configurations
 - Devices: MXG 1.2 (1), MXP (1), MXP Strada (1), MXS 1.2 Strada (1)
 - Manual Collections
 - Connected Devices: MXS Strada ID 6801000
 - Trash (7)
- Main Window:**
 - Header: MXS Strada ID 6801000 (USB)
 - Navigation: Live Measures, Properties, Settings, Tracks, Predictive Reference Lap, Counters, Logo, Firmware
 - Buttons: mV, Stop Forcing
- Table of Live Measures:**

Channel	Value	Channel	Value	Channel	Value
LoggerTemp	38.4 C	Channel08	-100 mV	Luminosity	4 %
Channel05	-99 mV	External Volta...	13.2 V		
ECU channels					
FuelInst1	--- %	ClutchPedalSw	--- #	TyreSize	--- #
FuelInst2	--- %	ESPEvent	--- #	RPM	2500 rpm
FuelLevelMean	--- %	ETCTelTal	--- #	SpeedFL	--- km/h
PedalPosition	--- %	FailSafeCool	--- #	SpeedFR	--- km/h
LateralAcc	--- g	MILTelTal	--- #	SpeedRL	--- km/h
SWAngle	--- deg	StabCtrlMTXT	--- #	SpeedRR	--- km/h
YawRate	--- deg/s	StabCtrlTeltal	--- #	SpeedVeh	--- km/h
ABSEvent	--- #	TCSBrakeEve...	--- #	Water Temp	--- C
ABSTelTal	--- #	TCSEngEvent	--- #	TrqAct	--- Nm
AxleRatio	--- #	TrqSource	--- #	FuelFlow	--- l
BrakeLampSw	--- #	TurboBoost	--- #	Gear	gear
BrakeWrnTelTal	--- #	TyreRvMile	--- #		
Calculated channels					
Bias Front Sp...	--- %	Bias Speed	--- %		
Bias Rear Spe...	--- %	Water Temp	104 #		
Lap channels					
Lap - Lap Num...	0	Lap - Split Nu...	0	Lap Time	0.00.000
Lap - Run Nu...	12	Lap - Split Time	0.00.000		

5.5.3 – Setting reference Lap

As explained in paragraph 4.4 it is possible to decide which lap time use as reference to compute the predictive lap time. Available options are:

- best lap of the test
- Best lap of today
- Previous Lap
- User reference lap

Once the reference lap selected you can use the arrow (s) that appear(s) left of the menu to change this settings.

For the setting to be operative you need do transmit it to your MX Strada; of course it is always possible to change the setting from the dash keyboard. The system always saves the last performed setting.

The screenshot shows the RaceStudio3 application window. The main title bar reads "MXS Strada ID 6801000 (USB)". The interface is divided into several sections:

- Left Panel:** Contains "All Configurations", "Devices" (listing MXG 1.2 (1), MXP (1), MXP Strada (1), and MXS 1.2 Strada (1)), "Manual Collections", "Connected Devices" (listing MXS Strada ID 6801000), and "Trash (7)".
- Top Navigation:** Includes tabs for "Live Measures", "Properties", "Settings" (selected), "Tracks", "Predictive Reference Lap", "Counters", "Logo", and "Firmware". Below these are "Refresh" and "Transmit" buttons.
- Main Content Area:**
 - Date Time:** Includes "Date Format" (MM/DD/YY), "Time Format" (24H), and "Time / Date Synchronization" (by GPS Track). A timestamp "11:17:31 12/16/2022" is displayed.
 - Predictive Time:** The "Reference Lap" dropdown menu is open, showing options: "Best Lap of Test", "Best Lap of Today" (highlighted in red), "Previous Lap", and "User Reference Lap".

5.5.4 – Setting Predictive Reference Lap

MX Strada can compute and show the predictive lap time using a reference lap stored in its memory or an user-generated reference lap. **Please note:** “Predictive and Reference Lap” tab appears in the device window only if the firmware of the connected dash supports it as shown here below. In case the tab is not available a firmware updated is to be performed (see chapter 8).

As shown here below, this view features three useful keyboard:

- top left and top right of the view are the keyboards to manage the file properties
- central is the keyboard to move the reference file(s) from/to PC/device.

The view has two columns:

- on the left the reference lap(s) file(s) stored in your PC
- on the right the reference lap(s) file(s) stored on MX Strada

At the very first time both columns of the view are empty except if a firmware generated file has been stored in the system. The firmware automatically generates reference files like the best of the test and the best lap of today as well as previous lap and they can be uploaded to the software using the keyboard.

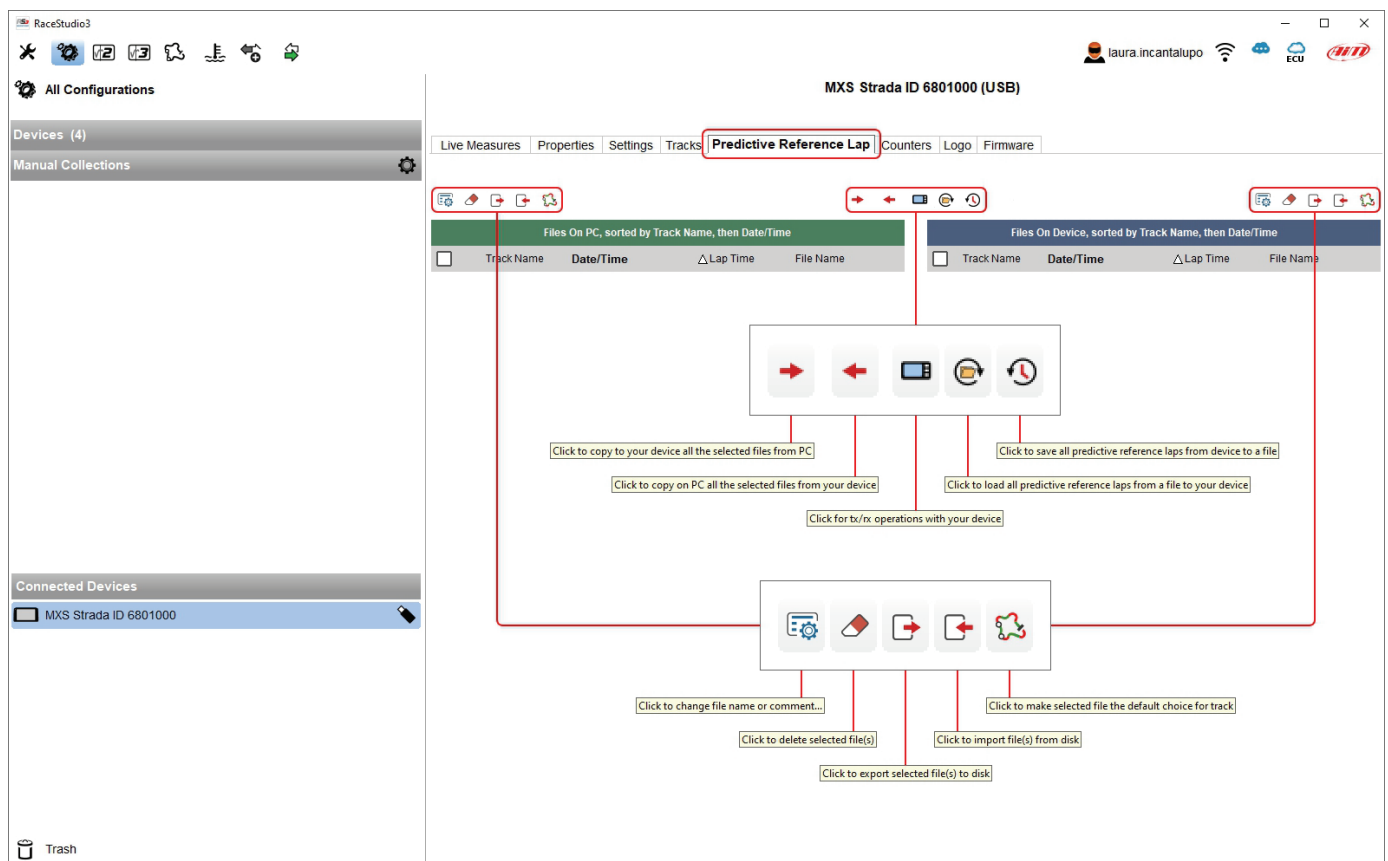

When the firmware generated file gets copied from the device to the PC you need to name it in the window that is prompted. It is also possible to fill in a comment.

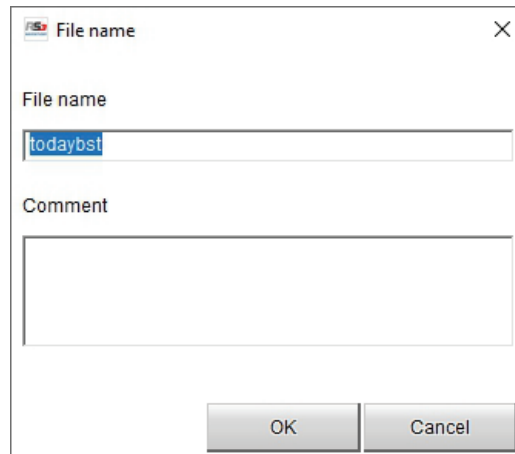

It is also possible to generate a new reference lap file in Race Studio 3 Analysis. This is very useful if you want to use a particular lap as reference for a specific track. To generate it:

- run Race Studio Analysis 3
- open a session
- click "Laps" button
- right click on the desired lap and select "Generate predictive reference lap from this lap"
- fill in the predictive reference lap panel that is prompted

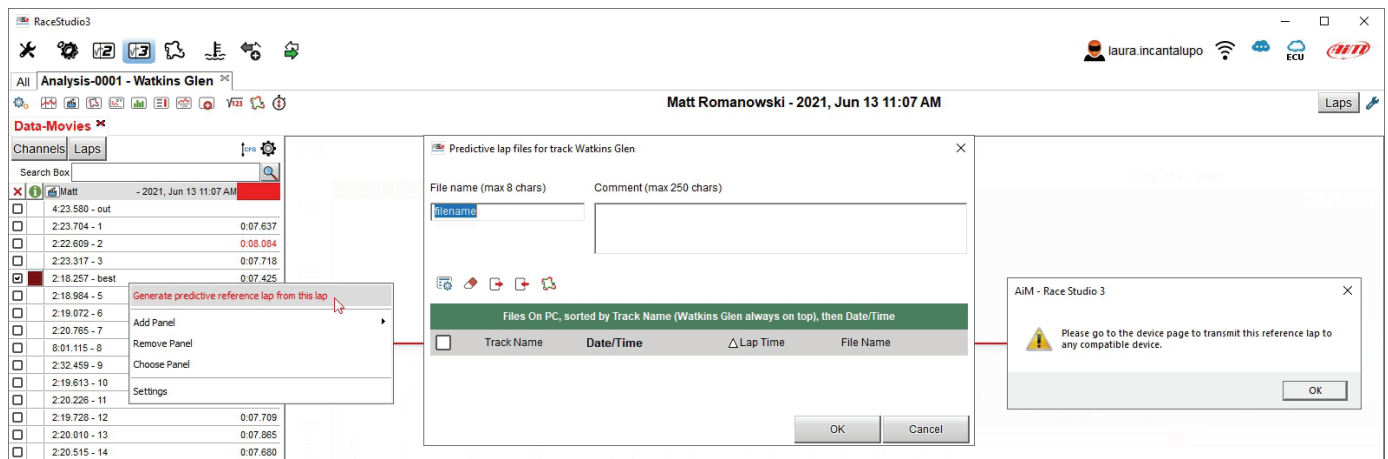

It is possible to save several lap files for each track and send them to the device that will automatically group them by track. Lap files shown in blue are the default files (one for each track) that the firmware will use as reference to compute the predictive lap time on that track.

It is possible to change the selected file using the dash keyboard or right clicking on each file. Using the central keyboard you can also export all files from a device and load them in another using the proper icons as shown at the beginning of this paragraph.

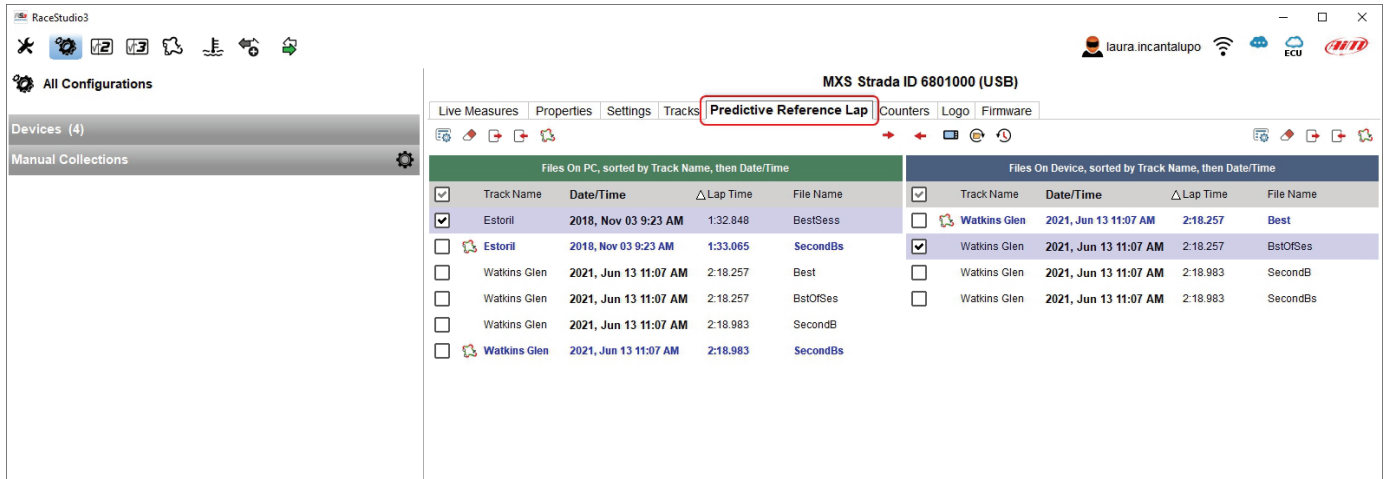

6 – On the track

MX Strada series can show up to eight pages. To scroll them press “>>” lateral button. Pages can change according to the device configuration.



7 – Data recall

At the end of the test sampled data can be recalled pressing “MEM/OK”.

First is “Today” page.
Press “TESTS”

TODAY 02.02PM

MAX RPM		MAX SPEED	
10048		282	
Lap	Best Laps	RPM	Km/h
4	1:57:56	10048 5592	280 73
11	1:57:94	10100 5450	277 70
8	1:58:02	10300 5700	278 69

Second is “Summary” page that shows all the last tests with date and place. Select the day to see and press “ENTER”.

TEST SESSIONS

TODAY: COTA Austin

- 21/07/2018: Albany GA
- 21/07/2018: Albany GA
- 20/07/2018: Albany GA
- 20/07/2018: Albany GA

Third is “Summary” page that shows all tests in a box with time of the test, number of laps and best lap of the test. Select the test to see and press “ENTER”.

TODAY: COTA Austin

02.02 PM 17 Laps B 1.57.56	12.02 AM 10 Laps B 1.50.46	10.43 AM 11 Laps B 1.54.14
09.52 AM 7 Laps B 1.55.56	09.02 AM 9 Laps B 1.53.46	7.39 AM 10 Laps B 1.55.16

This page is a histogram test summary. Moving the cursor left and right all laps and their lap time are shown.

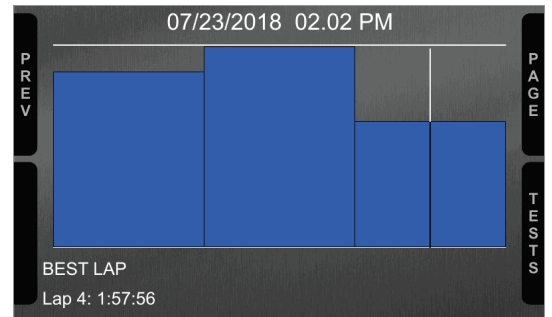

8 – New firmware upgrade



Our technicians and engineers are constantly working to improve both the firmware (the application that manages your device) and the software (the application installed on the PC).

Each time a new firmware and/or software version is available the icon here above appears with an arrow indicating that something is available for download (otherwise the icon only shows the cloud).

Click it and freely download the new applications.

The screenshot shows the RaceStudio3 (64 bit) 3.55.05 interface. On the left, there is a 'Connected Devices' list with three items: MXP Strada ID 6801000, EVO5 ID 5100668, and SmartyCam 3 Dual ID 5170. The main area displays a 'Software - Installed version: RaceStudio3 (64 bit) 3.55.05' table. The table has columns for 'Name', 'On the web', and 'Downloaded'. The 'MXS 1.3 Strada' row is highlighted in blue and has a red box around the version numbers '02.40.47' and '02.40.40'. A 'new' badge is visible next to the 'MXS 1.3 Strada' row.

Name	On the web	Downloaded	Info
<input type="checkbox"/> RaceStudio3 (64 bit)	3.55.05	3.55.05	
<input type="checkbox"/> MXS Strada	01.32.16	01.32.16	
<input type="checkbox"/> MyChron5	01.32.08	01.32.08	
<input type="checkbox"/> SmartyCam HD	01.04.56	01.04.56	
<input type="checkbox"/> MX2E	02.40.26	02.40.26	
<input type="checkbox"/> MXG 1.2	02.40.40	02.40.40	
<input type="checkbox"/> MXG 1.2 Strada	02.40.40	02.40.40	
<input type="checkbox"/> MXG 1.3	02.40.47	02.40.47	
<input type="checkbox"/> MXG 1.3 Strada	02.40.47	02.40.47	
<input type="checkbox"/> MXK10	02.28.58	02.28.58	
<input type="checkbox"/> MXK10(11-15)	02.28.58	02.28.58	
<input type="checkbox"/> MXP	02.40.40	02.40.40	
<input type="checkbox"/> MXP 1.3	02.40.47	02.40.47	
<input type="checkbox"/> MXP 1.3 Strada	02.40.47	02.40.47	
<input type="checkbox"/> MXP Strada	02.40.40	02.40.40	
<input type="checkbox"/> MXS 1.2	02.40.40	02.40.40	
<input type="checkbox"/> MXS 1.2 Strada	02.40.40	02.40.40	
<input type="checkbox"/> MXS 1.3	02.40.47	02.40.47	
new <input checked="" type="checkbox"/> MXS 1.3 Strada	02.40.47	02.40.40	
<input type="checkbox"/> MX UTV	02.40.40	02.40.40	
<input type="checkbox"/> MXm	02.40.40	02.40.40	
<input type="checkbox"/> MXsl	02.40.40	02.40.40	
<input type="checkbox"/> MyChron5-660	02.40.00	02.40.00	
<input type="checkbox"/> MyChron5S	02.40.40	02.40.40	

Once the new firmware has been downloaded connect your device to the PC using the USB cable to perform a firmware upgrade. In a few seconds the device is ready.

9 – RPM

MX Strada series dash can receive RPM value from the ECU. If on the contrary the vehicle does not have an ECU RPM can be sampled using the wire labelled "RPM" (corresponding to pin 21 of MX Strada series 23 pins connector).

9.1 – RPM from ECU

To get the RPM from the ECU just connect MX Strada series dash to the ECU and it will automatically sample that value.

Please note: if your vehicle ECU can be reached through an OBDII plug, a dedicated harness for MX Strada series AMP 14 pins connector is available, as shown at the end of this user guide.

9.2 – RPM via a 5-50V square wave or coil (150-400V)

If the vehicle has no ECU connect the wire labelled "RPM" (corresponding to pin 21) of the device 23 pins connector harness to the ignition system. This way MX Strada series can read the signal from the low voltage of the coil (whose peak can be from 150 to 400 V) or from a possible square wave (the peak can be from 5 to 50 V).

The image below shows an example of wiring of the ignition system.

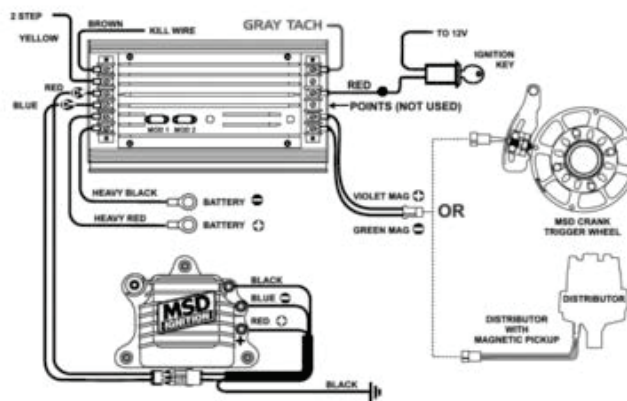

The output labelled "GRAY TACH" gives a 5-50V output that can be directly sampled by MX Strada series dash.

In case the vehicle ignition system has no output MX Strada series dash should be connected to the low voltage of the coil as shown in the following images.

Point 1: low voltage of the coil

Point 2: connected to the spark plug

Point 3: connected to the +12V of the battery

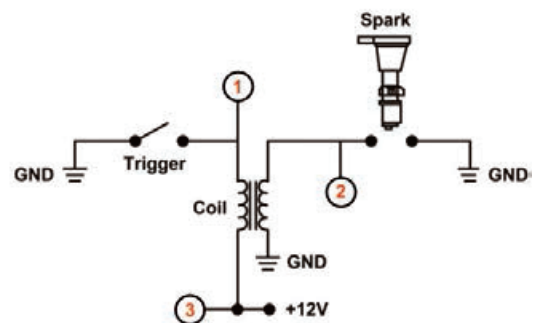
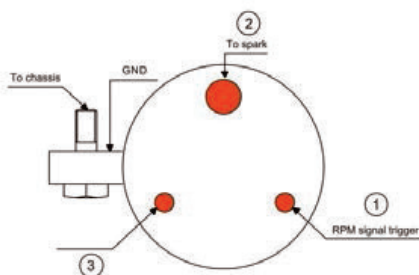



Once MX Strada series connected to RPM signal enable it and set its parameters in channels page of Race Studio 3 as explained in “Channels configuration” paragraph.

The screenshot shows the RaceStudio3 interface with the 'Channels' tab selected. A table lists various channels, and a 'Channel Settings' dialog box is open for the 'RPM' channel. The dialog box has three sections: 'Name' (set to 'RPM'), 'Function' (set to 'Engine RPM'), and 'Sensor' (set to 'RPM Sensor'). The 'RPM Parameters' section is also visible, showing 'RPM Max' set to 16000 and 'RPM Factor' set to /1. The 'Sampling Frequency' is set to 20 Hz. The 'Save' and 'Cancel' buttons are at the bottom of the dialog box.

ID	Name	Function	Sensor	Unit	Freq	Parameters
RPM	<input checked="" type="checkbox"/> RPM	Engine RPM	RPM Sensor	rpm	20 Hz	max: 16000 ; factor: /1 ;
Spd	<input type="checkbox"/> Speed	Vehicle Spd	Speed Sensor	km/h 0.1	20 Hz	wheel: 1600 ; pulses: 1 ;
Ch01	<input checked="" type="checkbox"/> Oil Pressure	Oil Pressure	0-5 bar abs (X05PSA00005Bxxx)	bar	1 Hz	
Ch02	<input checked="" type="checkbox"/> Steering Angle	Steering Pos	Angular Pot. AutoCal	deg	20 Hz	max travel: 1 ;
Ch03	<input checked="" type="checkbox"/> Fuel Level	Fuel Level	Fuel Level	l	2 Hz	
Ch04	<input checked="" type="checkbox"/> Gear	Gear	Gear Potentiometer	gear	20 Hz	
Ch05	<input checked="" type="checkbox"/> Channel05					
Ch06	<input checked="" type="checkbox"/> Channel06					
Ch07	<input checked="" type="checkbox"/> Channel07					
Ch08	<input checked="" type="checkbox"/> Channel08					
PAccu	<input checked="" type="checkbox"/> GPS PosAccuracy					
Spd	<input checked="" type="checkbox"/> GPS Speed					
Alt	<input checked="" type="checkbox"/> Altitude					
OdD	<input checked="" type="checkbox"/> Odometer					
Luma	<input checked="" type="checkbox"/> Luminosity					
Fuel	<input type="checkbox"/> FuelUsed					
Tlog	<input checked="" type="checkbox"/> LoggerTemp					

10 – Connection with the expansions

MX Strada series can be connected to AiM GPS08 Module, LCU-One CAN, Channel expansion, TC Hub and SmartyCam in order to improve its functionality.

Please note that LCU-one, Channel expansion TC HUB and SmartyCam HD have to be configured with Race Studio 3 software as already explained in the related paragraphs (“CAN Expansions configuration”, “Channels configuration” and “SmartyCam stream setting”).

Moreover, for further information concerning AiM expansions and AiM SmartyCam refer to the related manuals.

10.1 – Rear cameras connection and management

MX Strada Series dashes can manage rear cameras through the 5 pins Binder 712 female connector labelled “VIDEO IN” and placed rear central as shown here below. Please see the dash pinout reported in chapter 11 (Technical specifications and drawings) for further information about the Binder pinout.

The connector allows the connection of up to two analog cameras.



Rear cameras need to be connected to the logger, set in the logger configuration through Race Studio 3 software and executed through the logger keyboard. Here follows explanation of how to perform all these operations.

A wide number of analog cameras, both PAL and NTSC, are compatible with MX Strada series dashes and patch cables for connecting most of them are available. Please refer to our website www.aim-sportline.com for more information about them.

Please note: rear camera dimensions and MX Strada series camera input pinout are shown in chapter 11.

Once "Gear" channel set it is necessary to create a new "Trigger command". To do so:

- press "Add new command"
- fill in the panel that shows up, in the example
 - Description: park assistance
 - channel "Gear equal to R"
 - trigger the command "First camera input"

The screenshot shows the RaceStudio3 interface with the 'Trigger Commands' tab selected. A table lists several events and their corresponding alarms. The 'Parking Assistance' event is highlighted, and its alarm is 'First Camera Input'. Below the table, the 'Add New Command' button is highlighted with a red box. A 'Modify Output Command' dialog box is open, showing the configuration for the 'Parking Assistance' event. The 'Description' is 'Parking Assistance'. The condition is 'Gear == equal to R'. The action is 'First Camera Input'. The 'Save' button is also highlighted with a red box.

To perform the command on the dash press "MENU" button and scroll up to "VIDEO IN".



Set the camera as explained in paragraph 4.3. If no key is pressed in 5 seconds, the menu disappears and the dash shows the camera image in live streaming, that is very useful to check the camera position. Images below shows the image of the camera set on the left and the live stream on the right.

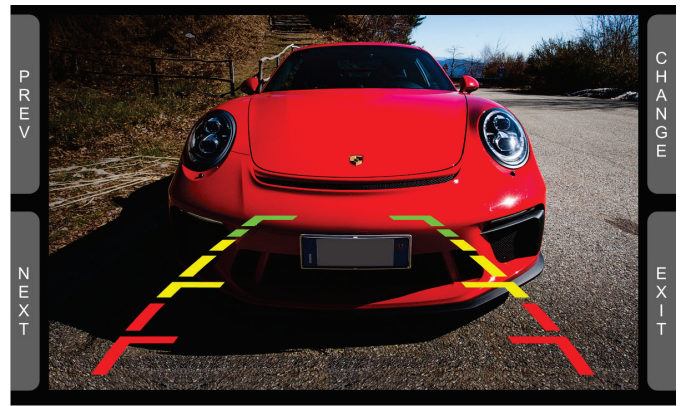
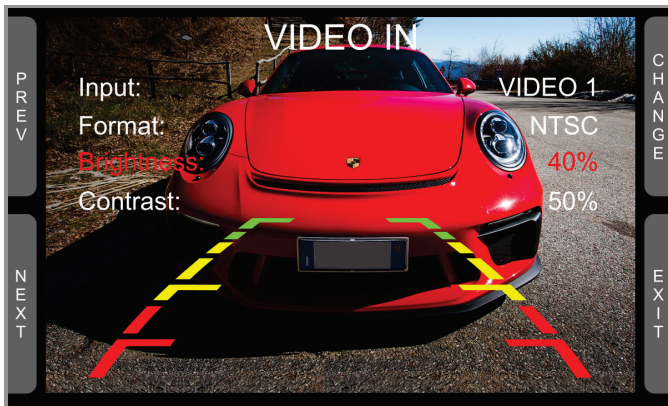



11 – Technical specifications and drawings

• TFT Display dimensions	5" (MXS Strada), 6" (MXP Strada), 7" (MXG Strada), 10" (MXT Strada)
• Display resolution	800x480 pixels (MXP Strada, MXG Strada, MXS Strada) 1280x480 pixels (MXT Strada)
• Contrast	600:1 (MXP Strada, MXS Strada), 1000:1 (MXG Strada), 1,100:1 (MXT Strada)
• Brightness	700cd/m ² – 1,100 Lumen (MXP Strada, MXG Strada, MXS Strada) 800cd/m ² (MXT Strada)
• Ambient light sensor	Yes
• Alarm Display Icons	Yes, freely configurable
• Alarm RGB LEDs	5 (MXP Strada), 8 (MXG Strada), 6 (MXS Strada and MXT Strada), configurable
• Shift lights	10 configurable RGB LEDs
• Display pages	Up to 8 freely configurable
• CAN connections	2
• Second CAN	Yes
• ECU Connection	CAN, RS232, K-Line to 1.000+leading ECUs
• External Modules	GPS Module, Channel Expansion, TC Hub, Lambda Controller, SmartyCam HD
• Analog inputs	8 fully configurable, max 1.000 Hz each
• Digital inputs	1 Speed input, coil RPM input
• Digital outputs	1 (1A each)
• Backlight	Yes
• Pushbuttons	Metallic
• Connectors	2 AMP connectors + 1 Binder connector
• Body	Anodized Aluminium
• Weight	480g (MXS Strada) 640g (MXP Strada) 950g (MXG Strada) 1,100g (MXT Strada)
• Dimensions	169.4x97x23mm (MXS Strada) 189.6x106.4x24.9mm (MXP Strada), 237X127.6X26mm (MXG Strada) 278x135x43.2mm (MXT Strada)
• Waterproof	IP65

11.1 – MX Strada series dimensions and pinout

MXS Strada dimensions in mm [inches]

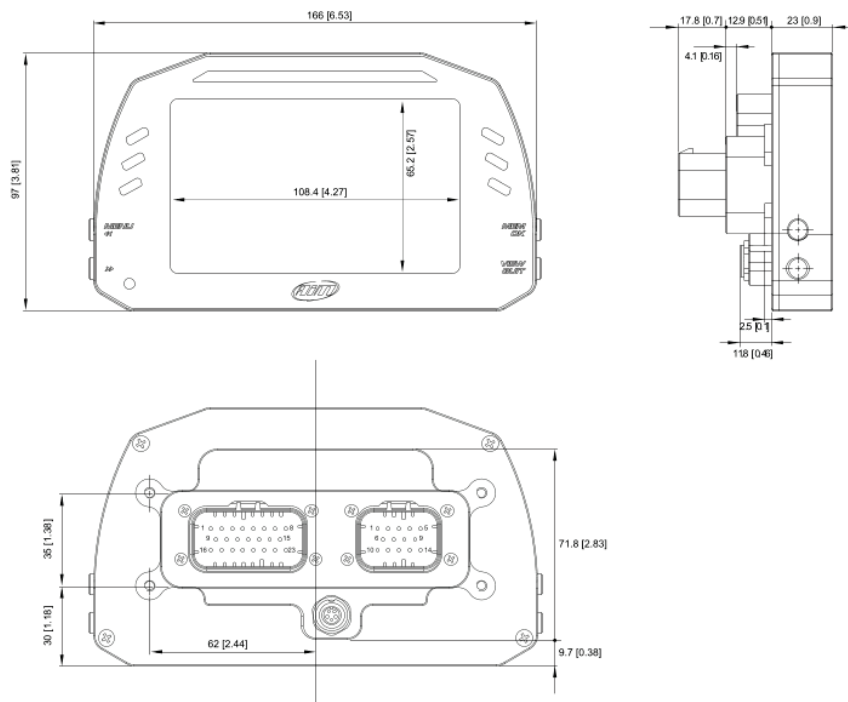



MXP Strada dimensions in mm [inches]

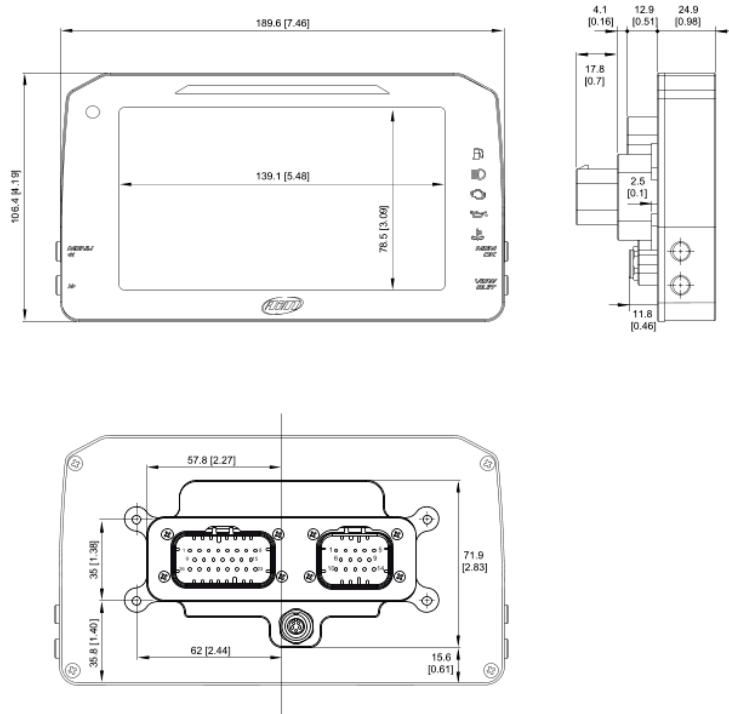



MXG Strada dimensions in mm [inches]

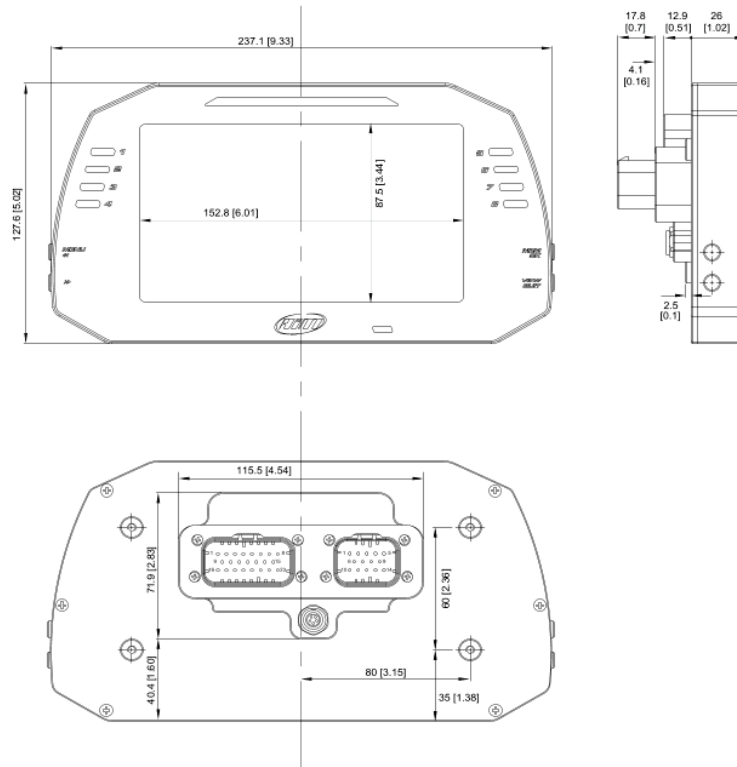



MXT Strada dimensions in mm [inches]

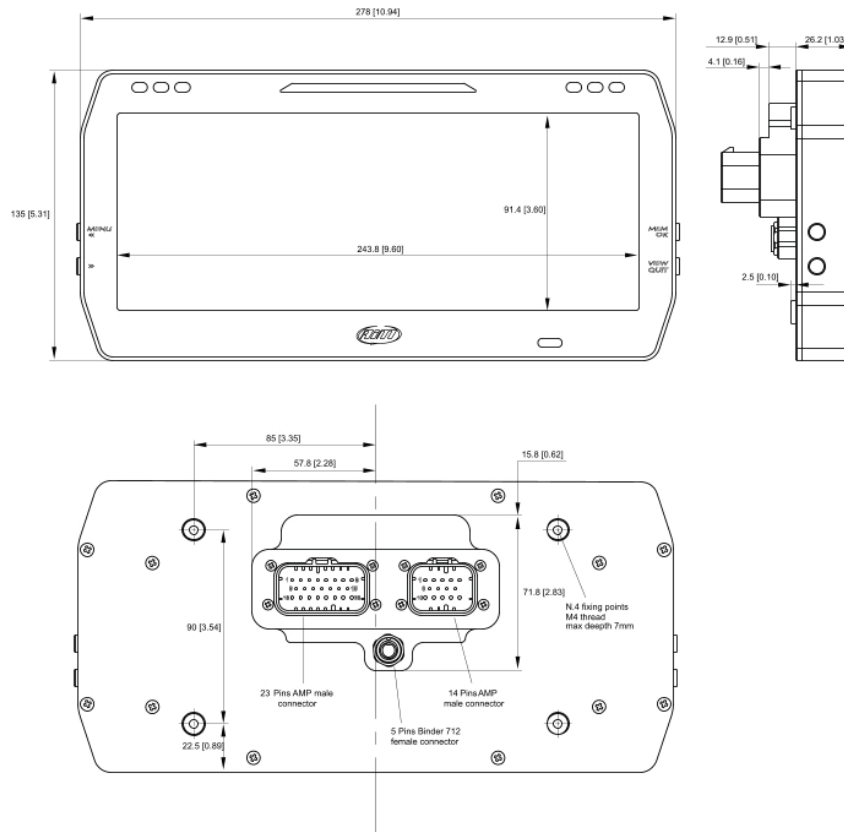

MX Strada Series pinout

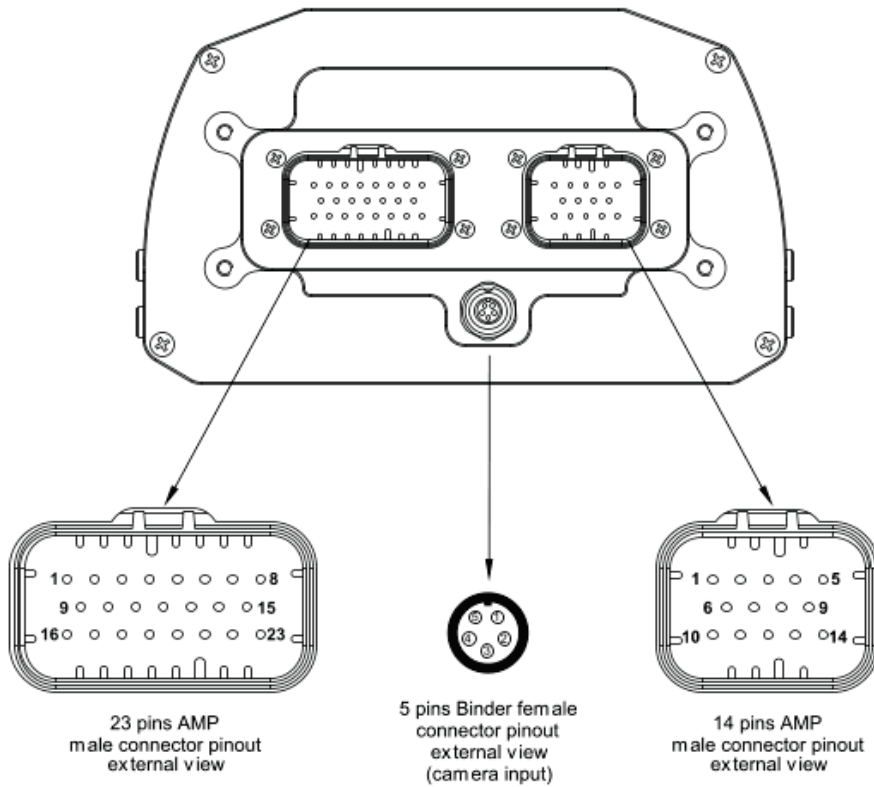

Pin	Function
1	Analog input 1
2	Analog GND
3	+Vb output
4	+Vreference
5	Analog input 2
6	Analog input 3
7	Analog GND
8	+Vb output
9	+Vreference
10	Analog input 4
11	Analog input 5
12	Analog GND
13	+Vreference
14	Analog input 6
15	Analog input 7
16	+Vreference
17	Analog input 8
18	Speed input
19	GND
20	Low Side output
21	RPM input
22	CAN 2+
23	CAN 2-

Pin	Function
1	Video input 1
2	GND
3	+Vb output camera
4	GND
5	Video input 2

Pin	Function
1	9-15v Power input
2	Battery GND
3	CAN+ Exp
4	GND
5	+Vb out CAN
6	CAN- Exp
7	+Vb Ext CAN
8	CAN1+/ECU RS232TX
9	CAN1-/ECU RS232RX
10	K Line ECU
11	USB D+
12	USB D-
13	USB GND
14	Reserved

11.2 – MX Strada harnesses

MX Strada series 14 pins AMP connector harness – standard version

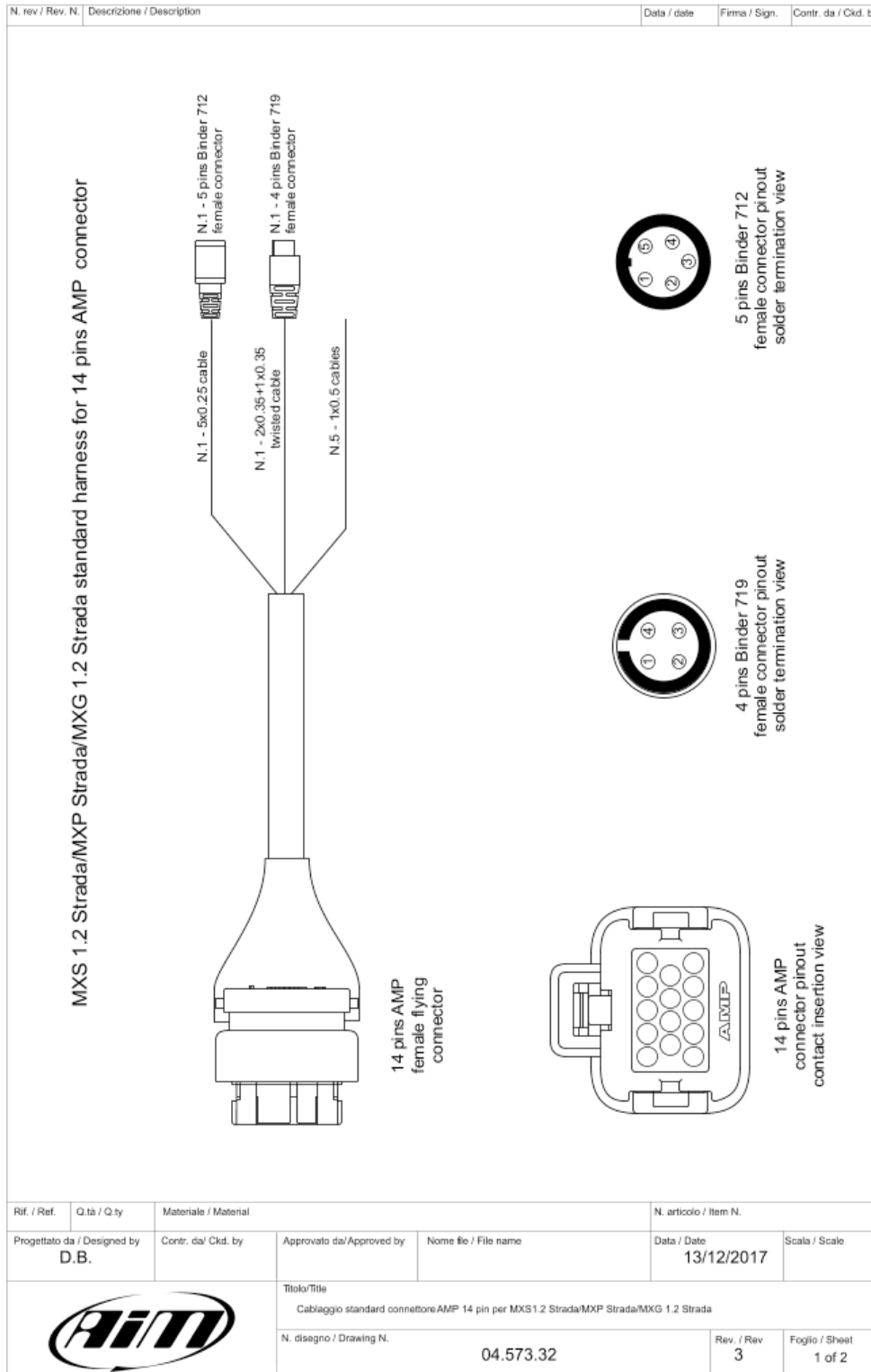

N. rev / Rev. N.	Descrizione / Description		Data / date	Firma / Sign.	Contr. da / Ckd. by	
Table of cables ending with 4 pins Binder 719 female connector						
14 pins AMP connector	Cable colour	Destination connector pin	Cable type	Length	Channel	Label
11 13 12	White twisted Black Blue twisted n.c.	1 2 3 4	twistato 2x0.35+1x0.35	1100mm	USB D+ USB GND USB D- n.c.	USB
Table of cables ending with 5 pins Binder 712 female connector						
14 pins AMP connector	Cable colour	Destination connector pin	Cable type	Length	Channel	Label
3 4 5 6 7	White Black Red Blue Orange	1 2 3 4 5	5x0.25 mm ²	350mm	CAN+ Exp GND Vb out CAN CAN- Exp Vb ext CAN	Exp
Table of not cabled cables						
14 pins AMP connector	Cable colour	Cable type	Length	Label		
2 1	Black Red	1x0.5 mm ² 1x0.5 mm ²	550mm	Battery GND 9-15V Power input		
8 9	White Blue	1x0.5 mm ² 1x0.5 mm ²	550mm	CAN1+/ECU RS232TX CAN1-/ECU RS232RX		
14	Yellow	1x0.5 mm ²	550mm	RESERVED		
Rif. / Ref.	Q.tà / Q.ty	Materiale / Material		N. articolo / Item N.		
Progettato da / Designed by	Contr. da/ Ckd. by	Approvato da/ Approved by	Nome file / File name	Data / Date	Scala / Scale	
D.B.				13/12/2017		
		Titolo/Title Cablaggio standard connettore AMP 14 pin per MXS 1.2 Strada/MXP Strada/MXG 1.2 Strada				
		N. disegno / Drawing N.	04.573.32	Rev. / Rev	Foglio / Sheet	
				3	2 of 2	

MX Strada series 23 pins AMP connector harness – standard version

N. rev / Rev. N.		Descrizione / Description		Data / date	Firma / Sign.	Contr. da / Ckd. by
<p>MXS Strada 1.2 standard harness for 23 pins AMP connector</p> <p>N.4 - 4x0.35 cables+</p> <p>N.5 - 3x0.35 cables</p> <p>N.4 - 1x0.5 cables</p> <p>N.9 - 4 pins Binder 719 female connectors</p> <p>23 pins AMP female flying connector</p> <p>4 pins Binder 719 female connector pinout solder termination view</p> <p>23 pins AMP female connector pinout contact insertion view</p>						
Rif. / Ref.	Q.tà / Q.ty	Materiale / Material		N. articolo / Item N.		
Progettato da / Designed by D.B.	Contr. da/ Ckd. by	Approvato da/Approved by	Noma file / File name	Data / Date 13/12/2017	Scala / Scale	
		Titolo/Title Cablaggio standard connettore AMP 23 pin per MXS1.2 Strada/MXP Strada/MXG 1.2 Strada				
		N. disegno / Drawing N.	04.573.33	Rev. / Rev	Foglio / Sheet 1 of 2	

N. rev / Rev. N.	Descrizione / Description	Data / date	Firma / Sign.	Contr. da / Ckd. by		
Table of cables ending with 4 pins Binder 719 female connectors						
23 pins AMP Connector pin	Cable colour	Destination connector pin	Cable type	Length	Channel	Label
1 2 3 4	White Black Red Blue	1 2 3 4	4x0.35mm ²	340mm	+Analog channel 1 Analog GND +Vb output +Vreference	Channel 1
5 2 3 4	White Black Red Blue	1 2 3 4	4x0.35mm ²	340mm	+Analog channel 2 Analog GND +Vb output +Vreference	Channel 2
6 7 8 9	White Black Red Blue	1 2 3 4	4x0.35mm ²	360mm	+Analog channel 3 Analog GND +Vb output +Vreference	Channel 3
10 7 8 9	White Black Red Blue	1 2 3 4	4x0.35mm ²	360mm	+Analog channel 4 Analog GND +Vb output +Vreference	Channel 4
11 2 nc 13	White Black n.c. Blue	1 2 3 4	3x0.35mm ²	380mm	+Analog channel 5 Analog GND nc +Vreference	Channel 5
14 12 nc 13	White Black n.c. Blue	1 2 3 4	3x0.35mm ²	380mm	+Analog channel 6 Analog GND nc +Vreference	Channel 6
15 12 nc 16	White Black n.c. Blue	1 2 3 4	3x0.35mm ²	400mm	+Analog channel 7 Analog GND nc +Vreference	Channel 7
17 12 nc 16	White Black n.c. Blue	1 2 3 4	3x0.35mm ²	400mm	+Analog channel 8 Analog GND nc +Vreference	Channel 8
18 19 3	White Black Blue n.c.	1 2 3 4	3x0.35mm ²	320mm	Speed 1 GND +Vb output nc	Speed
Table of not cabled cables						
23 pins AMP connector pin	Cable colour	Cable type	Length	Label		
20 21 22 23	Red White White Blue	1x0.5 mm ² 1x0.5 mm ² 1x0.5 mm ² 1x0.5 mm ²	550mm	Low Side digital output RPM Input CAN2+ CAN2-		
Rif. / Ref.	Q.tà / Q.ty	Materiale / Material		N. articolo / Item N.		
Progettato da / Designed by D.B.	Contr. da / Ckd. by	Approvato da / Approved by	Nome file / File name	Data / Date 13/12/2017	Scala / Scale	
		Titolo/Title Cablaggio standard connettore AMP 14 pin per MXS 1.2 Strada/MXP Strada/MXG 1.2 Strada				
		N. disegno / Drawing N. 04.573.33			Rev. / Rev	Foglio / Sheet 2 of 2

MX Strada series 14 pins AMP connector harness with OBDII connector

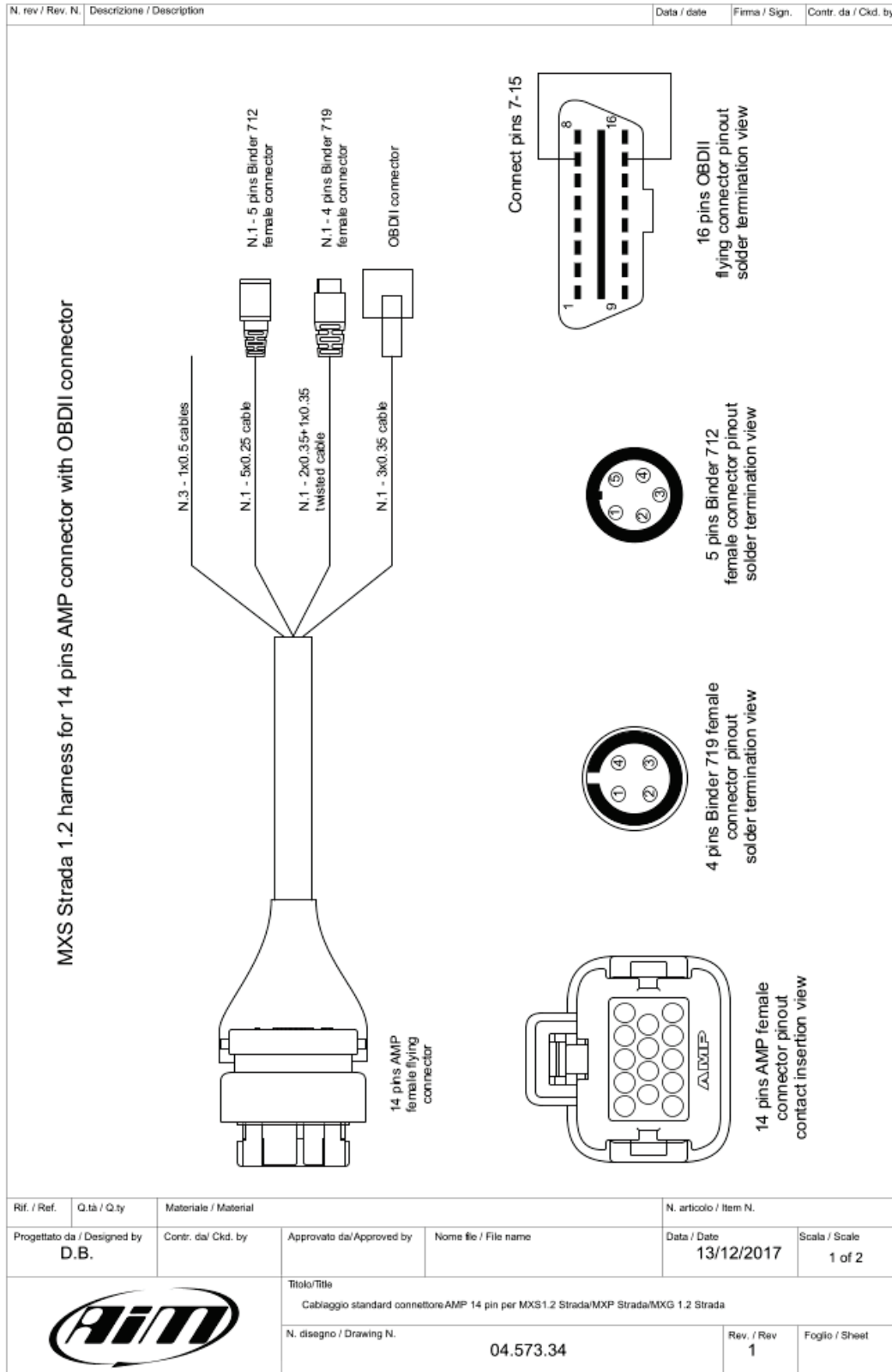

N. rev / Rev. N.	Descrizione / Description	Data / date	Firma / Sign.	Contr. da / Ckd. by		
Table of cables ending with 4 pins Binder 719 female connector						
14 pins AMP connector pin	Cable colour	Destination connector pin	Cable type	Length	Channel	Label
11 13 12	White twisted Black Blue twisted n.c.	1 2 3 4	2x0.35+1x0.35 twisted	1100 mm	USB D+ USB GND USB D- n.c.	USB
Table of cables ending with 5 pins Binder 712 female connector						
14 pins AMP connector	Cable colour	Destination connector pin	Cable type	Length	Channel	Label
3 4 5 6 7	White Black Red Blue Orange	1 2 3 4 5	5x0.25 mm ²	350 mm	CAN+ Exp GND Vb out CAN CAN- Exp Vb ext CAN	Exp
Rif. / Ref.	Q.tà / Q.ty	Materiale / Material		N. articolo / Item N.		
Progettato da / Designed by D.B.	Contr. da/ Ckd. by	Approvato da/ Approved by	Nome file / File name	Data / Date 13/12/2017	Scala / Scale	
		Titolo/Title Cablaggio standard connettore AMP 14 pin per MXS 1.2 Strada/MXP Strada/MXG 1.2 Strada				
		N. disegno / Drawing N. 04.573.34		Rev. / Rev 3	Foglio / Sheet 2 of 2	

MX Strada Series USB Cable

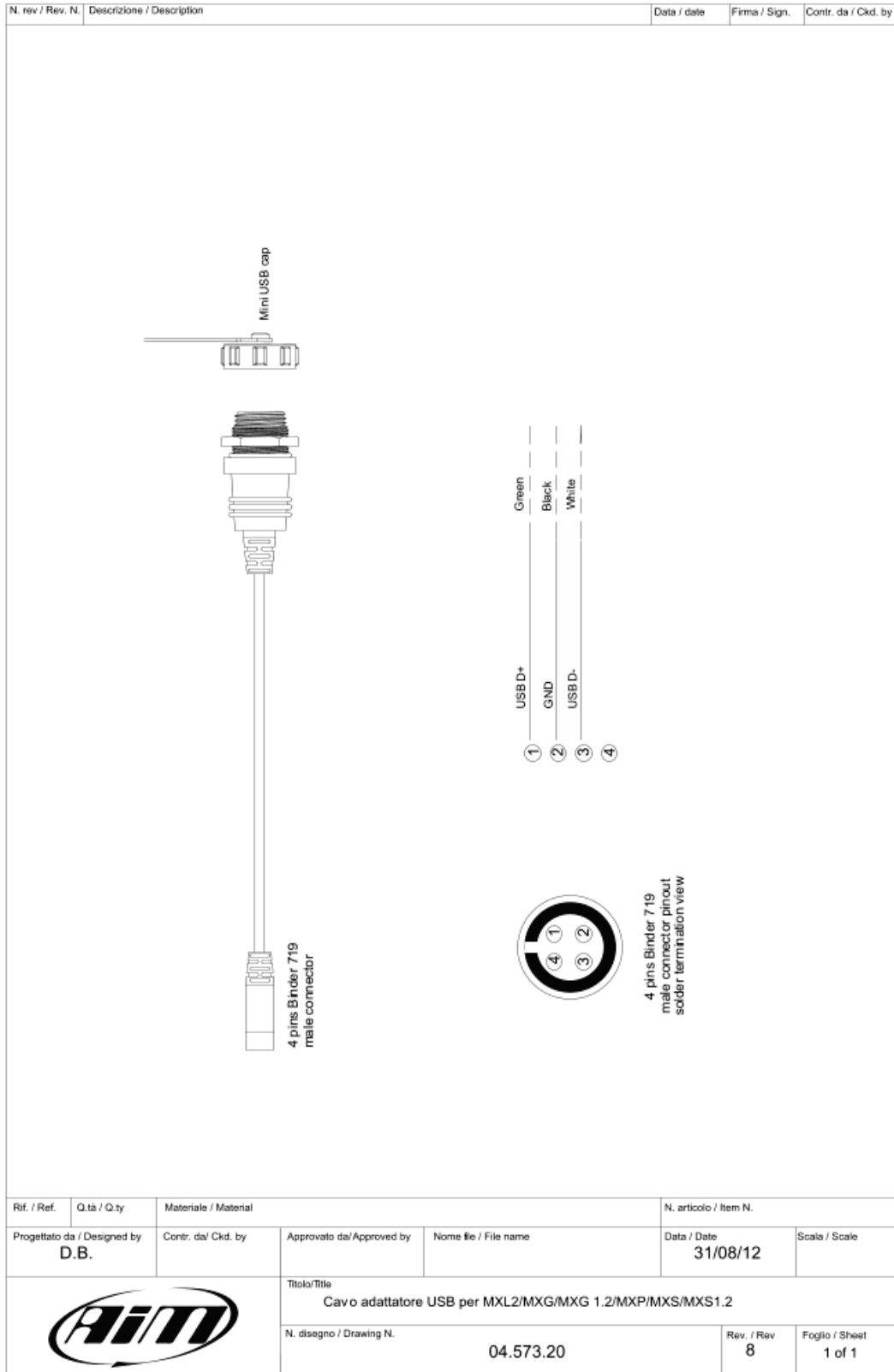

11.3 – MX Strada mirror cameras connections, dimensions, pinout and harnesses

MX Strada series mirror camera input

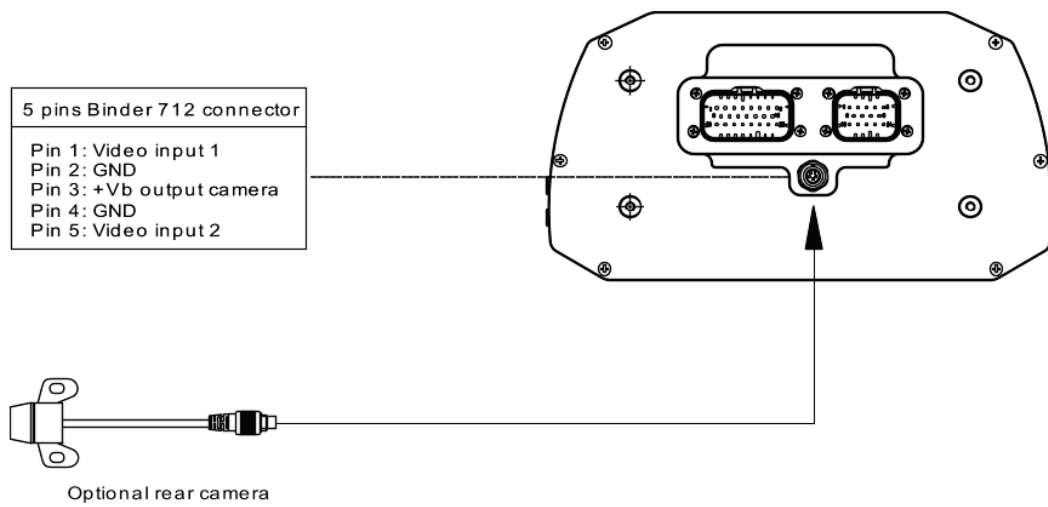

Mirror camera dimensions in mm [inches]

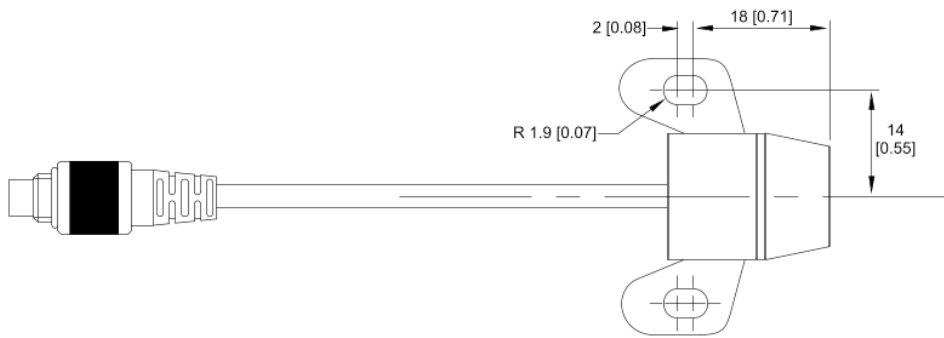
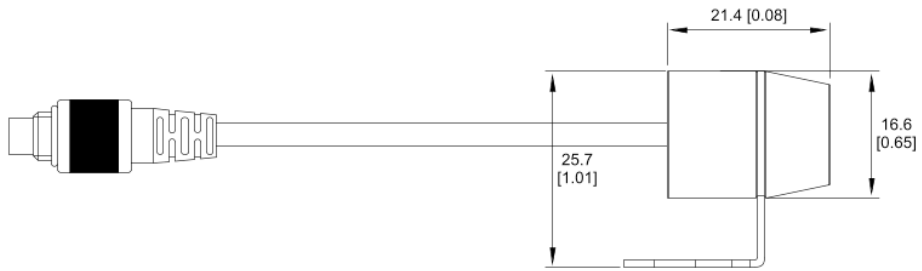

MX Strada series cable for single AiM mirror camera

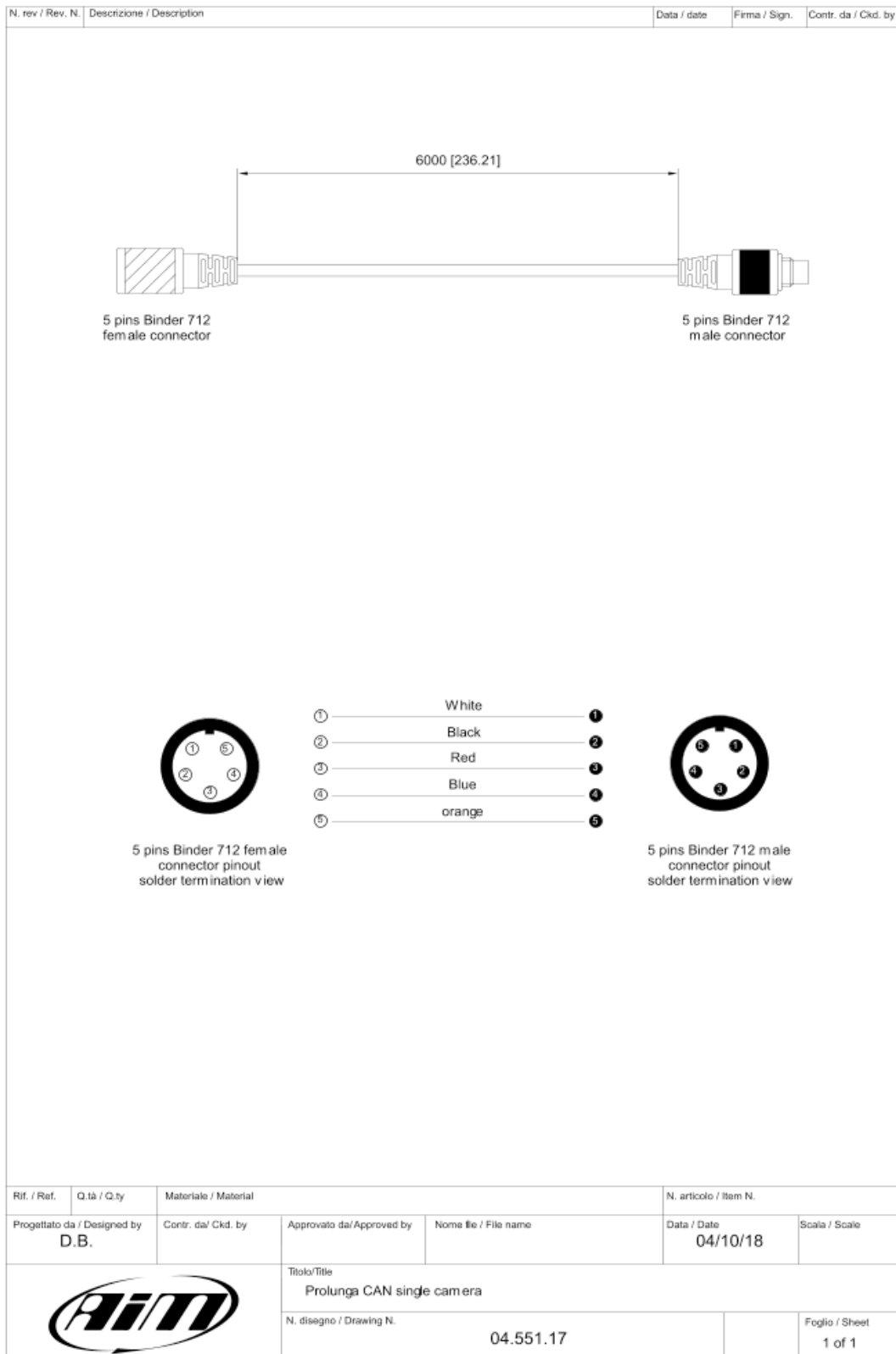

MX Strada series cable for n.2 AiM mirror camera

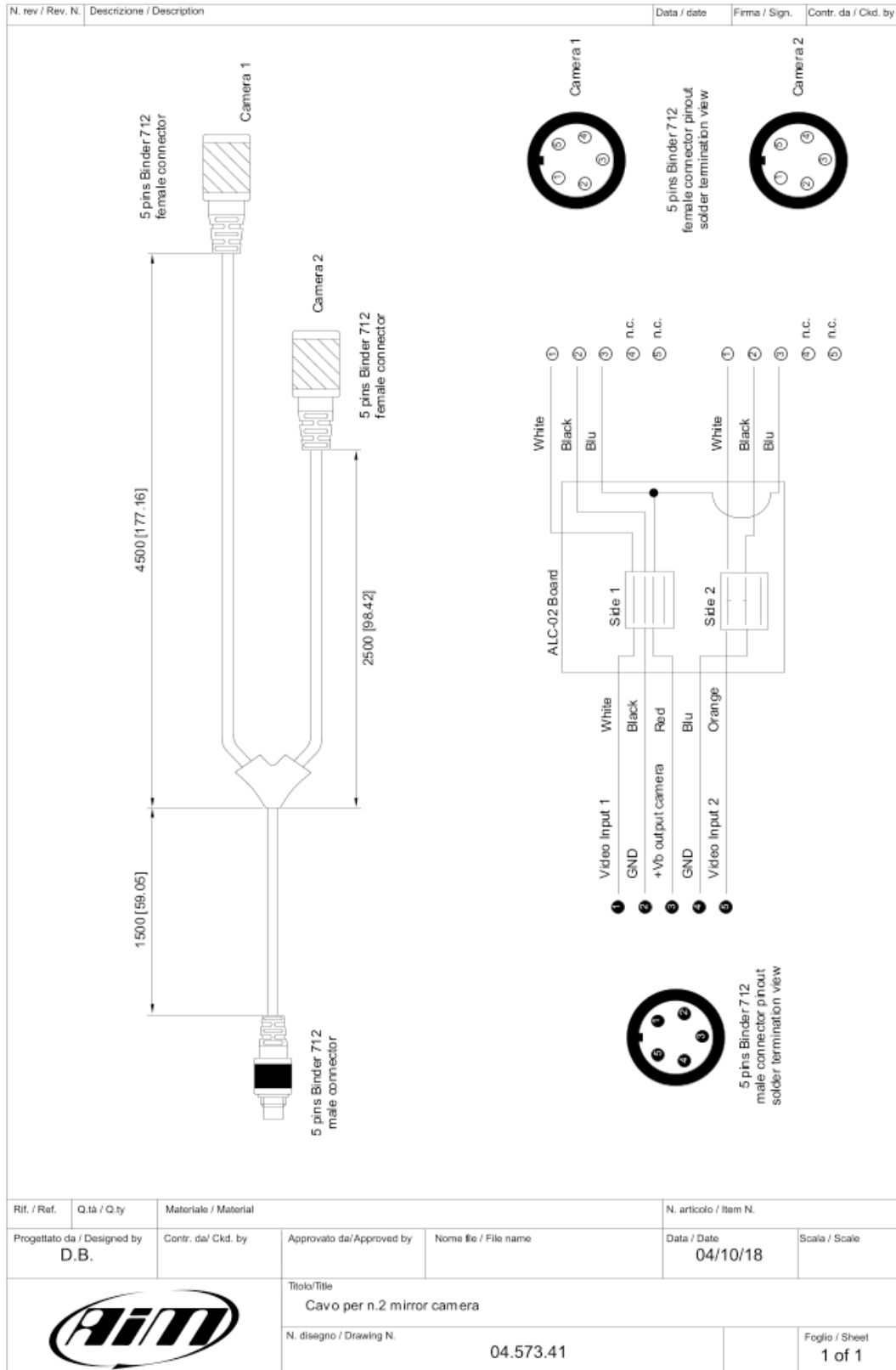

MX Strada series cable for single non AiM rear camera

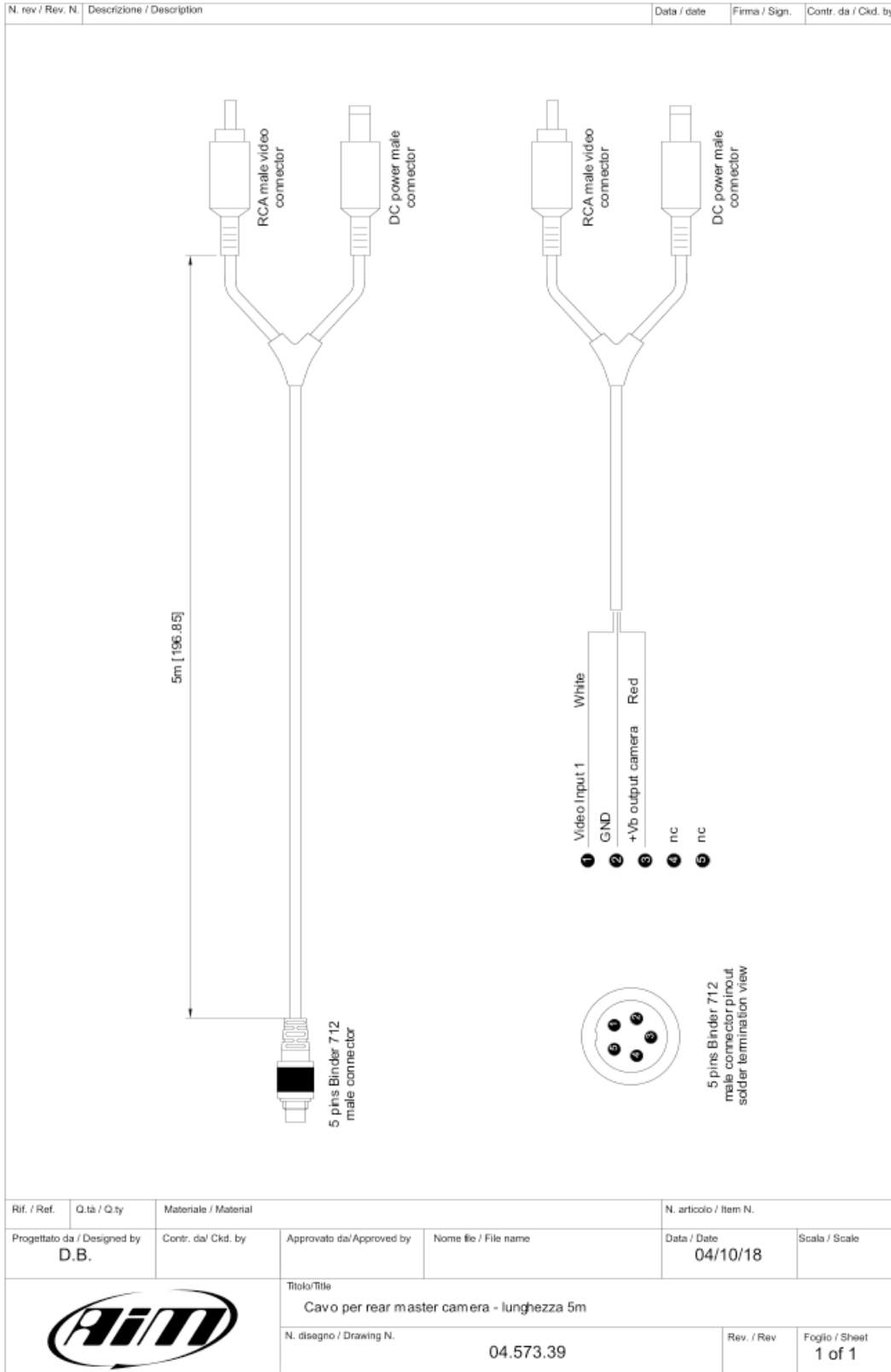

MX Strada series cable for n.2 non AiM rear cameras

