



AiM MXS Strada Light

Dash



Standard version



Street icons version

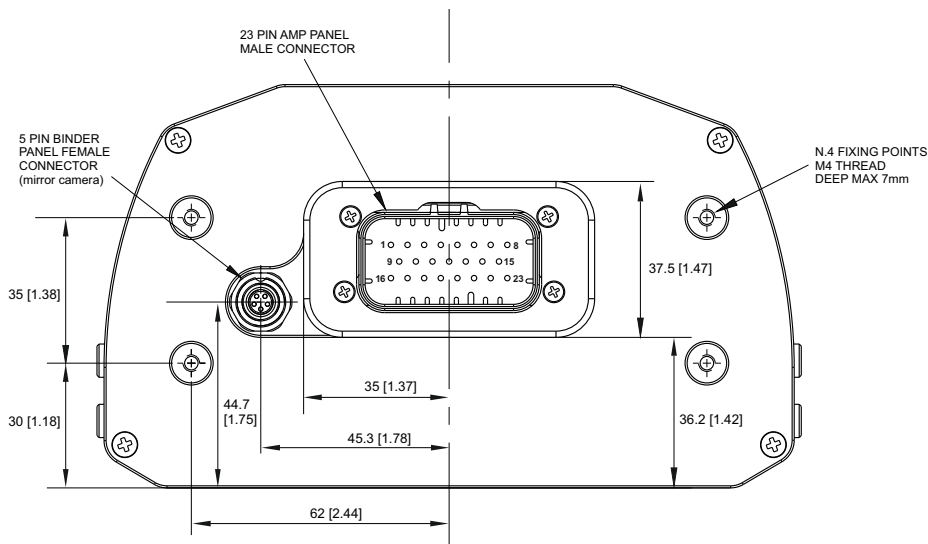
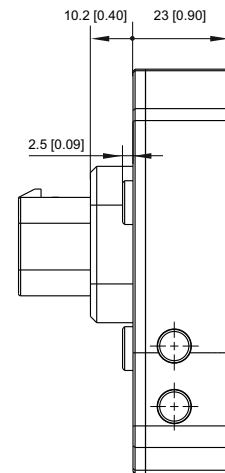
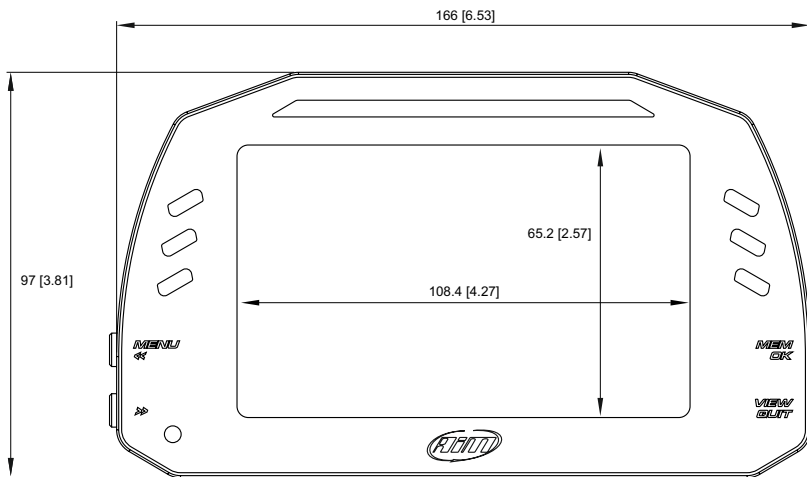



AiM MXS Strada Light

Dash

Technical specifications

Display	5" TFT
Resolution	800x480 pixels
Contrast	600:1
Brightness	700 cd/m2 - 1,100 Lumen
Ambient light sensor	Yes
Alarm LEDs	6 configurable RGB LEDs
Shift Lights	10 configurable RGB LEDs
CAN connections	3
ECU connection	CAN or K-Line to 2,000+ industry leading ECUs
External modules	GPS09c, ACC3, LCU Series, SmartyCam 3 Series
Analog inputs	4 fully configurable, max 500 Hz each
EXT video inputs	1 PAL-NTSC
Second CAN	Yes
Body	Anodized Aluminum
Pushbuttons	Metallic
Connectors	1 AMP connector + 1 Binder connector
Dimensions	169.4x97x33.2 mm
Weight	460 g
Power consumption	400 mA
Waterproof	IP67



AiM MXS Strada Light

Dash

Pinout

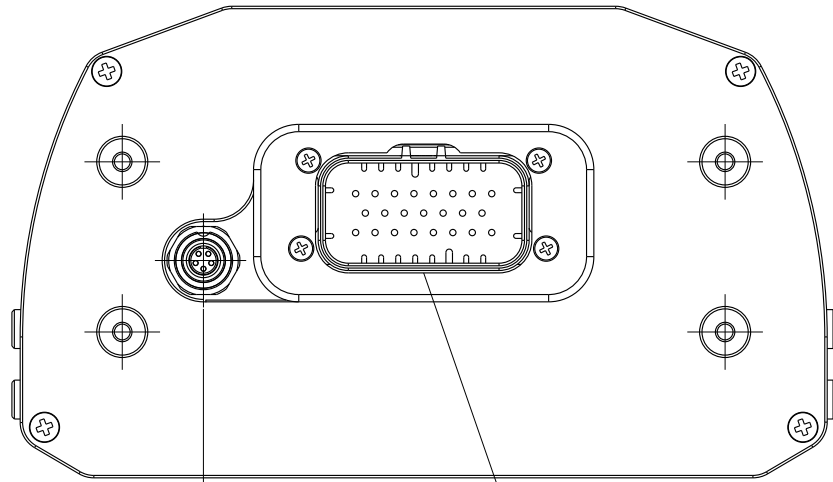

5 PINS binder 712 female connector (external view)

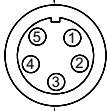

23 PIN AMP PANEL MALE CONNECTOR PINOUT EXT VIEW

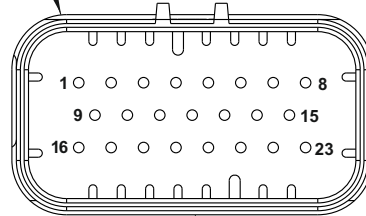

Pin	Function
1	Video input 1
2	GND
3	+Vb output CAM
4	GND
5	Video input 2

Pin	AMP 23 pin
1	9-15V Power in
2	GND batt
3	CH AN 1
4	CH AN 2
5	+Vb out
6	CAN+ exp
7	CAN- exp
8	+Vb ext can
9	CAN1+
10	CAN1-
11	CH AN 3
12	CH AN 4
13	+5Vref
14	+Vb out CAN
15	GND
16	K-line ECU
17	GND
18	USB D+
19	USB D-
20	GND
21	Reserved
22	CAN2+
23	CAN2-



AiM MXS Strada Light

Dash

Standard harness

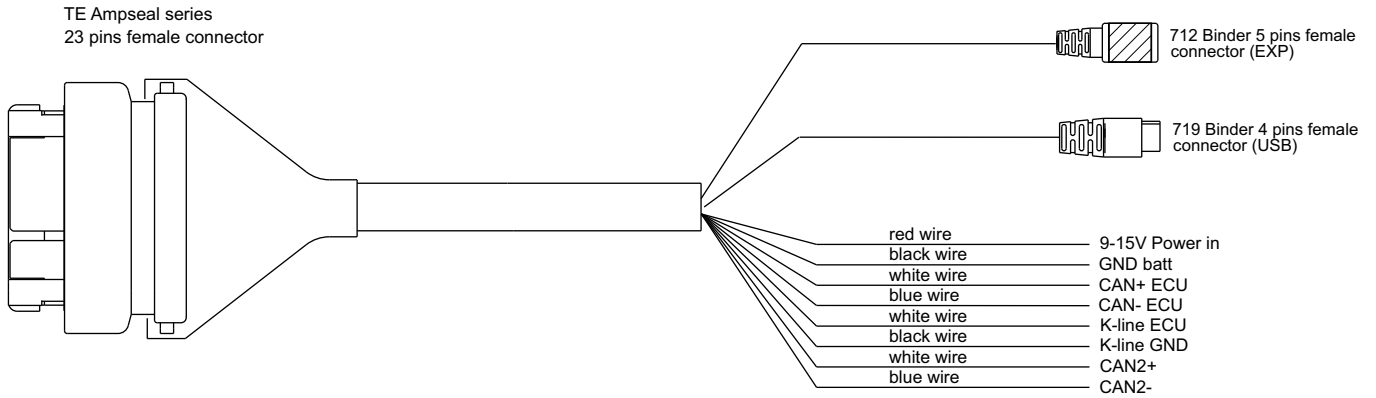

Part number

V02573630 Standard harness

Full harness

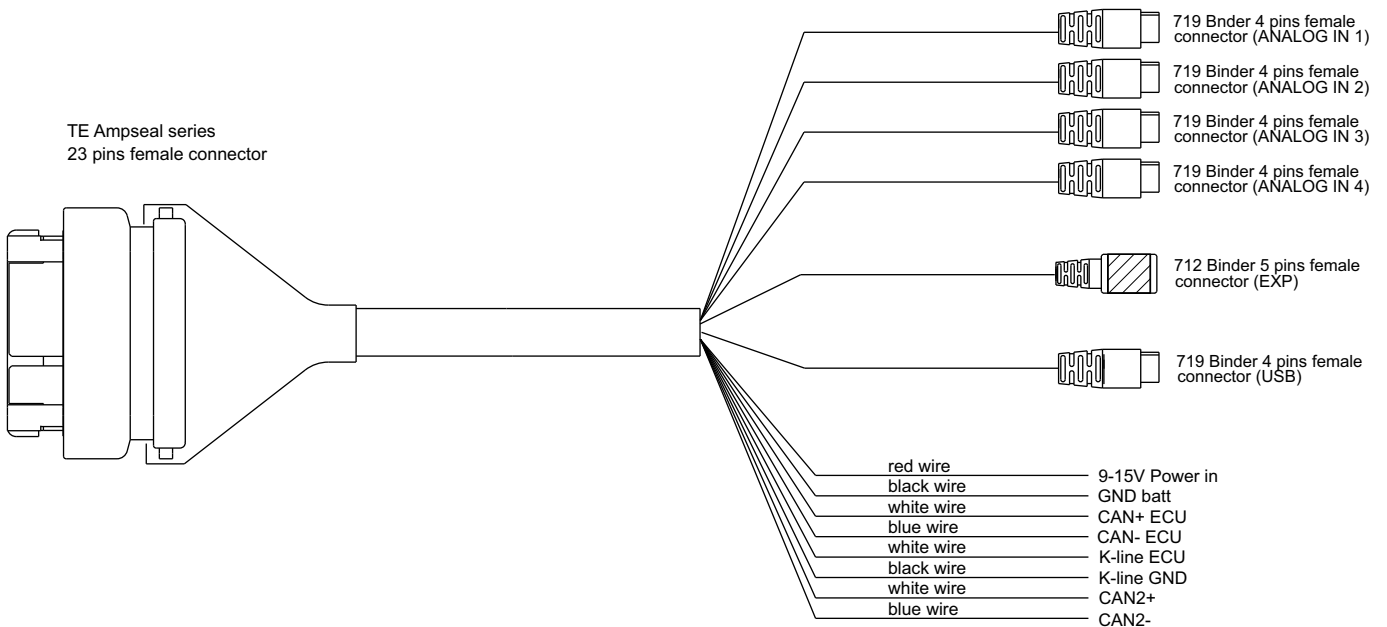

Part number

V02573620 Full harness







AiM MXS Strada Light





Dash

Kits, accessories & spare parts





Kit 1 MXS Strada Light, Standard version + 23 pins Standard harness

Description	Part number	The kit contains
MXS Strada Light Standard version + 23 pins Standard harness	XXMSLGTASH	   





Kit 2 MXS Strada Light, Standard version + 23 pins Full harness

Description	Part number	The kit contains
MXS Strada Light Standard version + 23 pins Full harness	XXMSLGTAFH	   

Kit 3 MXS Strada Light, Street icons version + 23 pins Standard harness

Description	Part number	The kit contains
MXS Strada Light Street icons version + 23 pins Standard harness	XXMSLGTISH	   

Kit 4 MXS Strada Light, Street icons version + 23 pins Full harness





Description	Part number	The kit contains
MXS Strada Light Street icons version + 23 pins Full harness	XXMSLGTIFH	   



AiM MXS Strada Light

Dash

Harnesses & cables

Harnesses	Part number		
23 pins Standard harness	V02573630		
23 pins Full harness	V02573620		
Cables	Part number		
Amphenol-Mini USB Adapter	V02573200		
USB-Mini USB cable 200 cm	X90TMP002	